

# User Manual



Centurion Tower  
PSCE1000/2000/3000

Online UPS

Uninterruptible Power Supply System



## NetGuard<sup>®</sup>

UPS Monitoring Software

### IMPORTANT

Download the latest NetGuard Monitoring Software:

[www.powershield.com.au/index.php/downloads](http://www.powershield.com.au/index.php/downloads)

Default password is: administrator

# Introduction

Thank you for choosing PowerShield.

PowerShield Centurion UPS series are designed to provide the highest level of protection against disturbances found on electrical power supply lines. It is suitable for most applications including IT, security, telephone, broadcasting, medical\*<sub>1</sub> etc.

The Centurion UPS series are designed to provide the most comprehensive protection for your valuable electronic equipment, hardware, software and data from harmful disturbances found on AC power lines including blackouts, power sags, power surges, under voltage, over voltage, line noise, frequency variation, switching transients and harmonic distortions. The Centurions true online double conversion topology will continuously protect your equipment by internally isolating your equipment from the utility power ensuring that all your equipment always receives clean, uninterrupted and stable power.

## **Very Important !! : WARRANTY REGISTRATION**

In order to validate product warranty, it is essential that you register your UPS on line.

Please Visit PowerShield on line product warranty web page

**[www.powershield.com.au/register-products/](http://www.powershield.com.au/register-products/)**

This user manual contains instructions relating to safety, installation, operation, maintenance and warranty of this product.

Please keep this manual in a safe place for future references.

\*1: PowerShield does not recommend to use any of its products in life support application and /or in direct patients care.

## Special Symbols

The following symbols are used on the UPS to alert you to important information.

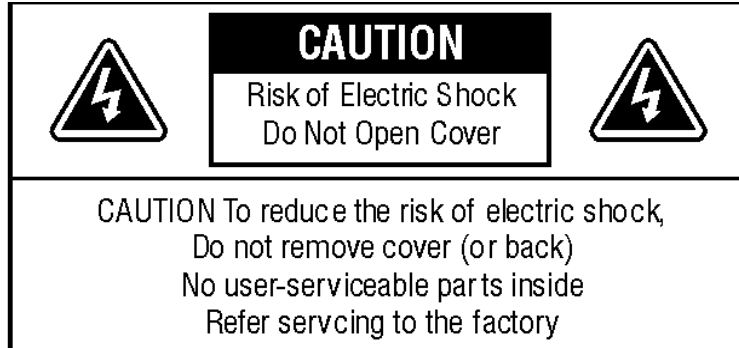

### **RISK OF ELECTRIC SHOCK -**

Indicates that a risk of electric shock is present and the associated warning should be observed



### **CAUTION; REFER TO OPERATOR'S MANUAL -**

Refer to your operator's manual for additional information, such as important operating and maintenance procedures.



### **SAFETY EARTHING TERMINAL -**

Indicates the primary safety ground.

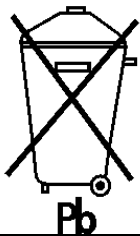

This symbol indicates that you should not discard the UPS or the UPS batteries in the trash. The UPS may contain sealed, lead-acid batteries. Batteries must be recycled.

# Table of Contents

1. Important Safety Warning.....	1
1-1. Transportation.....	1
1-2. Preparation .....	1
1-3. Installation .....	1
1-4. Operation .....	2
1-5. Maintenance, service and faults .....	2
2. Installation and setup.....	3
2-1. Rear panel view .....	3
2-2. Setup the UPS.....	4
3. Operations.....	7
3-1. Button operation .....	7
3-2. LCD Panel.....	8
3-3. Audible Alarm .....	9
3-4. LCD display wordings index.....	9
3-5. UPS Setting.....	10
3-6. Operating Mode Description .....	14
3-7. Faults Reference Code .....	15
3-8. Warning indicator .....	16
4. Troubleshooting .....	17
5. Service .....	19
6. Storage and Maintenance .....	20
6-1. Operation .....	20
6-2. Storage .....	20
7. Contacting PowerShield .....	20
8. Specifications.....	21

## 1. Important Safety Warning

For safety reasons, it is essential to comply with all warnings and operating instructions listed in this manual. Do not operate the UPS unit before carefully reading through all safety information and operating instructions. It is recommended that you save and or backup this manual for future reference.

### 1-1. Transportation

- Transport the UPS system using only the original packaging to protect against shock and impact.
- **Handling Safety**



Do not lift heavy loads without assistance.



<18 kg



18–32 kg



32–55 kg



>55 kg

This equipment is intended for installation in a controlled temperature indoor area free from conductive contaminants.

### 1-2. Preparation

- The UPS system must be absolutely dry before installation. As condensation may occur if the UPS system is moved directly from cold to warm environments, allow at least two hours for the UPS system to acclimate to the environment.
- Do not install the UPS system near water or in moist environments.
- Do not install the UPS system where it would be exposed to direct sunlight or near heaters.
- Do not block ventilation holes in the UPS housing.

### 1-3. Installation

- Do not connect appliances or devices that may overload the UPS system (e.g. laser printers) to the UPS output sockets.
- To ensure against physical hazards, place cables safely such that persons cannot accidentally trip over or step on them.
- Do not connect domestic appliances such as hair dryers to UPS output sockets.
- The UPS can be operated by any individual without previous experience.
- Always connect the UPS system to an earthed shockproof outlet that is easily accessible and close to the UPS system.

- Use only VDE-tested, CE-marked mains cable (e.g. the mains cable of your computer) to connect the UPS system to the building wiring outlet (shockproof outlet).
- Use only VDE-tested, CE-marked power cables to connect the loads to the UPS system.
- When installing the equipment, ensure that the sum of the leakage currents of the UPS and the connected devices do not exceed 3.5mA.

#### 1-4. Operation

- Do not disconnect the mains cable on the UPS system or the building wiring outlet (shockproof socket outlet) during operations as this will cancel and invalidate the protective earth of the UPS system and of all connected loads.
- As the UPS system features its own internal current source (high capacity batteries), the UPS output sockets may be electrically live even if the UPS system is not connected to the building wiring outlet.
- In order to fully disconnect the UPS system, first press the OFF/Enter button to disconnect the mains.
- Prevent fluids or other foreign objects from entering inside the UPS system.

#### 1-5. Maintenance, service and faults

- The UPS system operates with hazardous voltages. Repairs should only be carried out by qualified maintenance personnel.
- **Caution** - risk of electric shock. Even after the unit is disconnected from the mains, building wiring outlet, components inside the UPS system are still connected to the battery and electrically live and dangerous.
- Before carrying out any kind of service and/or maintenance; switch off mains power, then disconnect the batteries and verify that no hazardous voltages are present at the terminals of the large storage capacitors (the BUS-capacitors).
- Only persons who are adequately familiar with high capacity batteries, and with the understanding of the required precautionary measures outlined below, are permitted to replace batteries and supervise operations. Unauthorized persons must be kept well away from the batteries.
- **Caution** - risk of electric shock. The battery circuit is not isolated from the input voltage. Hazardous voltages may occur between the battery terminals and the ground. Before touching, always verify that no voltage is present!
- Batteries may cause electric shock and have very high short-circuit currents. When working with batteries always ensure the following precautionary measures are adhered to:
  - remove all jewellery items (wristwatches, rings and metal objects)
  - use only tools with insulated grips and handles.
- When changing batteries, always install the same model and type of batteries.
- Do not attempt to dispose of batteries by burning as they may explode.
- Do not open or destroy batteries. Escaping electrolyte can cause injury to the skin and eyes and may be toxic.
- Replacement fuses must be of the same type and amperage (current rating) in order to avoid fire hazards.
- Do not dismantle the UPS system.

## 2. Installation and setup

**NOTE:** Before installation, please inspect the unit. Be sure that nothing inside the package is damaged. Please keep the original package in a safe place for future use.

**NOTE:** There are two different types of online UPS: standard and long-run models. Please refer to the following model table.

**NOTE :** Long Runtime UPS systems do not contain batteries in the UPS system. Battery bank needs to be purchased when Long Runtime model is used.

Model Number	Type	Model Number	Type
PSCE1000	Standard Runtime	PSCE1000L	Long Runtime
PSCE2000		PSCE2000L	
PSCE3000		PSCE3000L	

### 2-1. Rear panel view

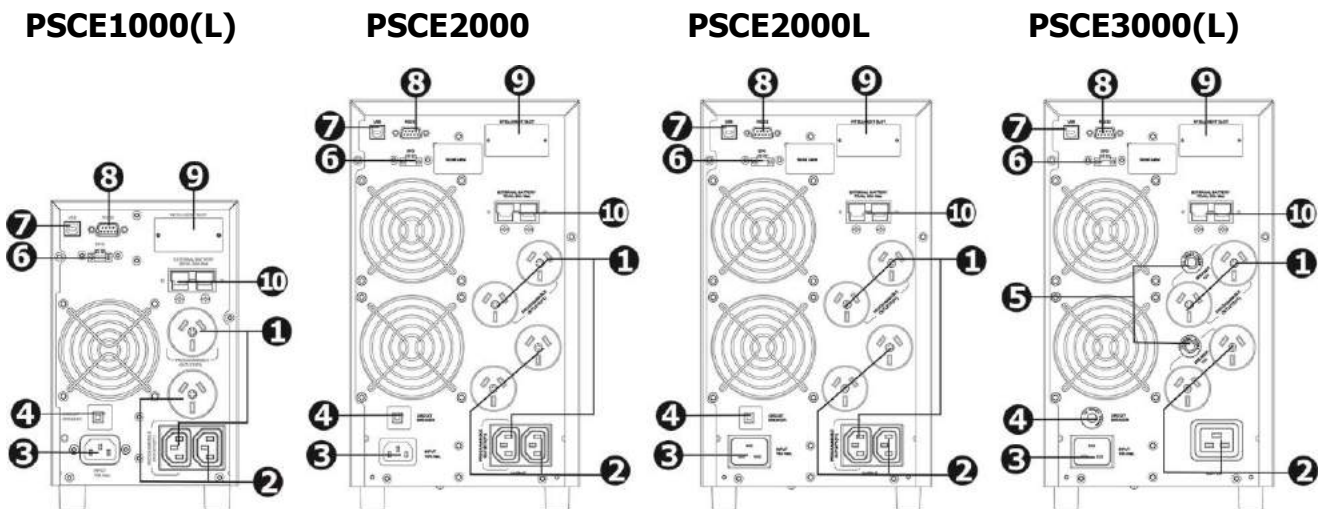

1. Programmable outlets (**WHITE COLOUR OUTLETS**): connect to non-critical loads.
2. General outlets (**BLACK COLOUR OUTLETS**): connect to mission-critical loads.
3. AC input inlet
4. Input circuit breaker
5. Output circuit breaker
6. Emergency power off function connector (EPO)
7. USB communication port
8. RS-232 communication port
9. SNMP /AS400 intelligent slot
10. External battery connection
11. 15A outlet

## 2-2. Setup the UPS

### Step 1: UPS input connection

Plug the UPS input cord into a two-pole, three-wire, grounded receptacle only. Avoid using extension cords.

- Centurion series come with Australian power cord in the package.  
For 1000/2000VA : 10A Australian input plug to IEC socket  
For 3000VA : 15A Australian input plug to IEC socket

### Step 2: UPS output connection

- There are two kinds of outlets on this model: **programmable outlets ( Marked in White colour )** and **general outlets( Marked in black colour )**. Please connect non-critical devices to the **programmable outlets** and critical devices to the **general outlets**. During power failure, you may extend the backup time to critical devices by setting shorter backup time for non-critical devices.

### Step 3: External Battery Bank connection

- There are external battery banks available on each models for gaining more battery backup time. Please check following instruction for connecting external battery bank to the unit.
- Please provide enough space between UPS and external battery bank for ventilation. Also, do not stack battery banks. Stacking results in a tipping hazard.

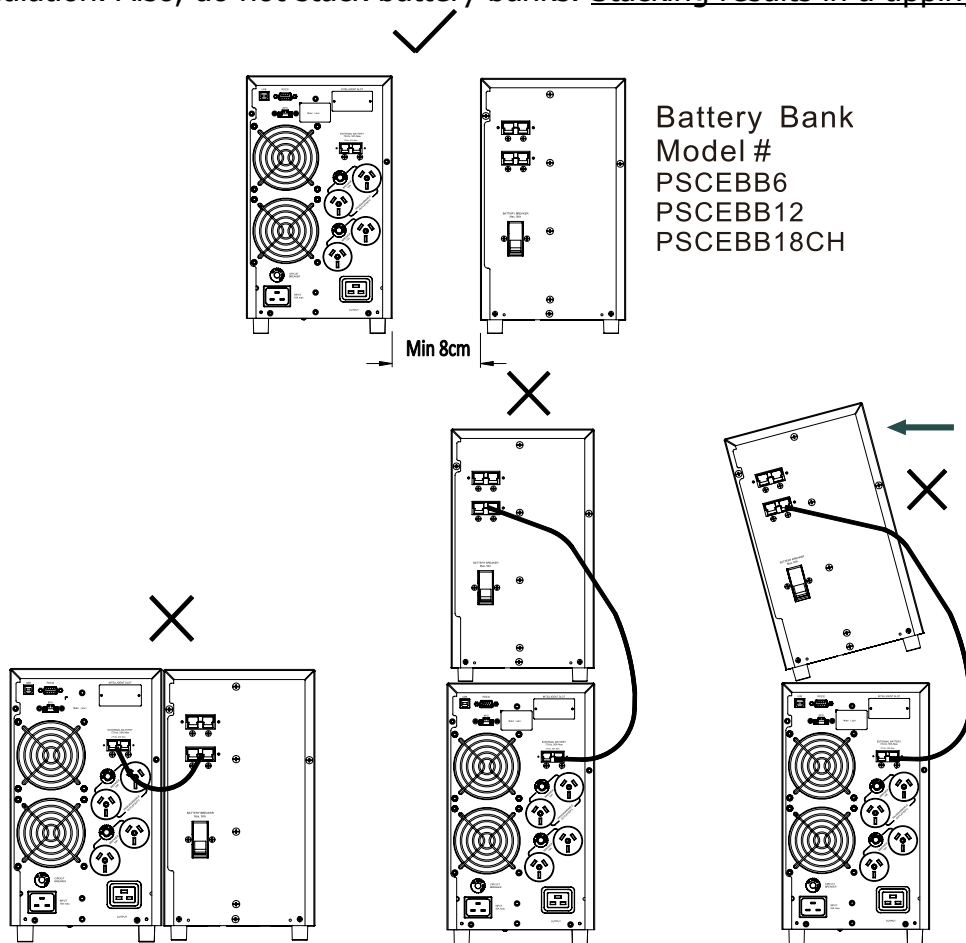

1. Remove DC connector cover from the rear panel of the unit and from the



battery bank input connector.

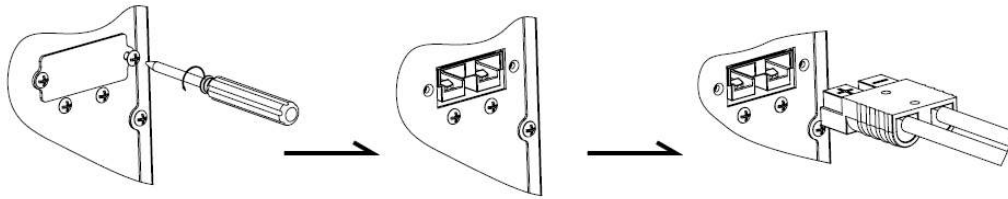

2. Connect DC cable from the DC connector of UPS rear panel to the input DC connector of Battery bank. Turn on battery circuit breaker of Battery banks.

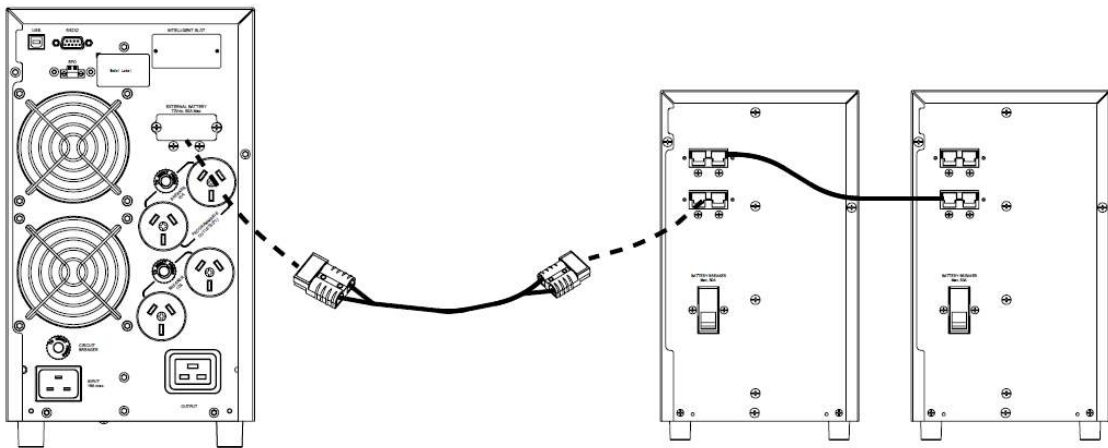

**NB :** Battery banks can be used with both types of UPS's. Although standard battery banks can be used with Long run UPS's usually these would have a customised larger battery bank. Standard battery banks are used more commonly with standard UPS's to increase backup times  
For installation of PSCEBB18CH. Please refer detail installation manual included in the package of its product.

#### Step 4: Communication connection

##### Communication port:

###### **USB port**



###### **RS-232 port**

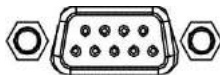

###### **Intelligent slot**

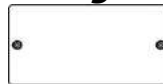

To allow for unattended UPS shutdown/start-up and status monitoring, connect the communication cable one end to the USB/RS-232 port and the other to the communication port of your PC. With the monitoring software installed, you can schedule UPS shutdown/start-up and monitor UPS status through PC.

The UPS is equipped with intelligent slot perfect for SNMP or AS400 card. When installing SNMP or AS400 card in the UPS, it will provide advanced communication and monitoring options.

**Note : AS400 and SMNP card cannot work at the same time.**

## Step 5: Disable and enable EPO ( Emergency Power Off ) function

Keep the pin 1 and pin 2 closed for UPS normal operation. To activate EPO( Emergency Power Off ) function, cut the wire between pin 1 and pin 2.

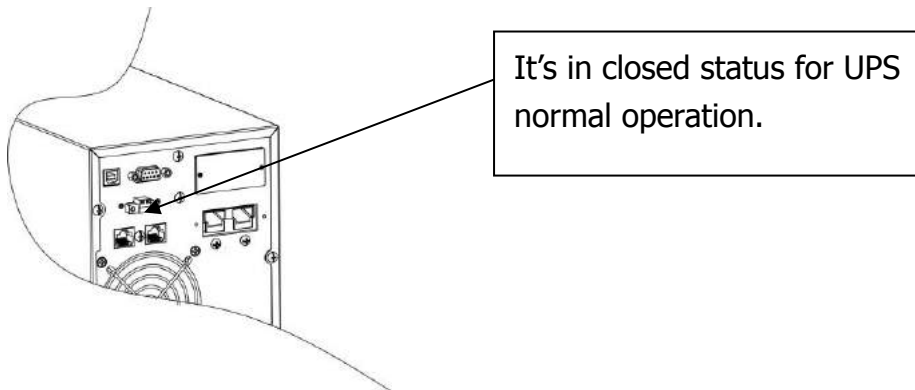

## Step 6: Turn on the UPS

Press the ON/Mute button on the front panel for two seconds to power on the UPS.

**Note:** The battery charges fully during the first five hours of normal operation. Do not expect full battery run capability during this initial charge period.

Unit will perform "Self test " for 10 seconds and go to On line mode.

Note : Cold Start operation. When the UPS is off and there is no mains power, use cold start feature to apply power to the connected equipment from the UPS's battery. Cold start is not a normal condition.

To cold start the unit, push and hold the ON/mute button until you will hear a long beep. During the long beep, release the button and the unit will cold start.

Note : Unit is on battery mode therefore, the run time is limited.

## Step 7: Install software

For optimal computer system protection, install NetGuard monitoring software to fully configure UPS shutdown that is included in the package.

In order to install the software, insert provided NetGuard CD into CD-ROM to install the monitoring software.

Please follow steps below to download and install monitoring software from the internet:

1. Go to the website <http://www.powershield.com.au>
2. Click PowerShield NetGuard software icon and then choose your required OS to download the software.
3. Follow the on-screen instructions to install the software.
4. When your computer restarts, the monitoring software will appear as an orange plug icon located in the system tray, near the clock.

## 3. Operations

### 3-1. Button operation

Button	Function
ON/Mute Button	<ul style="list-style-type: none"><li>➤ Turn on the UPS: Press and hold ON/Mute button for at least 2 seconds to turn on the UPS.</li><li>➤ Mute the alarm: After the UPS is turned on in battery mode, press and hold this button for at least 3 seconds to disable or enable the alarm system. This does not mute other warnings or errors.</li><li>➤ Up key: Press this button to display previous selection in UPS setting mode.</li><li>➤ Switch to UPS self-test mode: Press ON/Mute buttons for 3 seconds to enter UPS self-testing while in AC mode, ECO mode, or converter mode.</li></ul>
OFF/Enter Button	<ul style="list-style-type: none"><li>➤ Turn off the UPS: Press and hold this button for at least 2 seconds to turn off the UPS. UPS will switch off to standby mode under power normal or transfer to Bypass mode if the Bypass setting has been enabled.</li><li>➤ Confirm selection key: Press this button to confirm selection in UPS setting mode.</li></ul>
Select Button	<ul style="list-style-type: none"><li>➤ Switch LCD message: Press this button to change the LCD message for input voltage, input frequency, battery voltage, battery capacity and ambient temperature, output voltage, output frequency, load current and load percentage. It will return back to default display when pausing for 10 seconds.</li><li>➤ Setting mode: Press and hold this button for 3 seconds to enter UPS setting mode when in Standby or Bypass mode.</li><li>➤ Down key: Press this button to display next selection in UPS setting mode.</li></ul>
ON/Mute + Select Button	<ul style="list-style-type: none"><li>➤ Switch to bypass mode: When the main power is normal, press ON/Mute and Select buttons simultaneously for 3 seconds. Then UPS will enter to bypass mode. This action will be ineffective when the input voltage is out of acceptable range.</li><li>➤ Exit setting mode or return to the upper menu: When working in setting mode, press ON/Mute and Select buttons simultaneously to return to the upper menu. If it's already in the top menu, press these two buttons at the same time to exit the setting mode.</li></ul>

### 3-2. LCD Panel

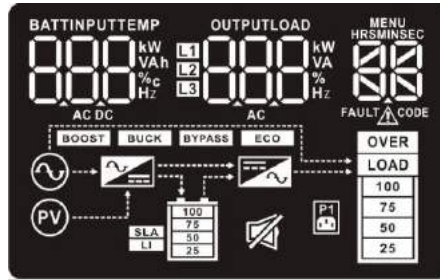

Display	Function
<b>Backup time information</b>	
	Indicates the remaining backup time in numbers. HRS: hours, MIN: minutes, SEC: seconds
<b>Warning &amp; Fault information</b>	
	Indicates that a warning and fault occurs.
	Indicates the warning and fault codes as listed in detail in section 3-7 and 3-8.
<b>Setting Operation</b>	
	Indicates the setting operation, and the setting items are listed in details in section 3-5.
<b>Battery, Input, Temperature, Output and Load information</b>	
	Indicates the input voltage, input frequency, battery voltage, battery capacity and ambient temperature. k: kilo, W: watt, V: voltage, A: ampere, %: percent, °C: centigrade degree, Hz: frequency, AC: alternating current, DC: direct current
	Indicate the output voltage, output frequency, load current and load percentage. k: kilo, W: watt, V: voltage, A: ampere, %: percent, Hz: frequency, AC: alternating current
<b>Load information</b>	
	Indicates the load level by 0-24%, 25-49%, 50-74%, and 75-100%.
	Indicates overload.
<b>UPS status</b>	
	Indicates that programmable management outlets are working.
	Indicates the UPS alarm is disabled.
	Indicates the UPS is working in bypass mode.
	Indicates the UPS powers the output directly from the mains
	Indicates the UPS connects to the mains.
	Indicates the UPS connects to the PV
	Indicates the AC to DC circuit is working
	Indicates the inverter circuit is working

## Battery information



Indicates the Battery level by 0-24%, 25-49%, 50-74%, and 75-100%.

### 3-3. Audible Alarm

Battery Mode	2 beeps every 30 seconds
Bypass Mode	Sounding every 10 seconds
Low Battery	Sounding every second
Overload	2 short beeps every 2 seconds
Fault	Continuously sounding

### 3-4. LCD display wordings index

Abbreviation	Display content	Meaning
ENA	ENA	Enable
DIS	DIS	Disable
CF	CF	Constant Frequency Constant Voltage
BAT	BAT	Battery
HLS	HLS	High loss
LLS	LLS	Low loss
BAH	BAH	Battery AH
CHA	CHA	Charger current
CBV	CBV	Charger boost voltage
CBF	CBF	Charger float voltage
AUT	AUT	Automatic
AON	AON	Always on
ESC	ESC	Escape
ON	ON	ON
OK	OK	OK
EP	EP	EPO
TP	TP	Temperature
CH	CH	Charger
BF	BF	Battery Fault
FU	FU	Bypass frequency unstable
BR	BR	Battery Replacement
EE	EE	EEPROM error

### 3-5. UPS Setting

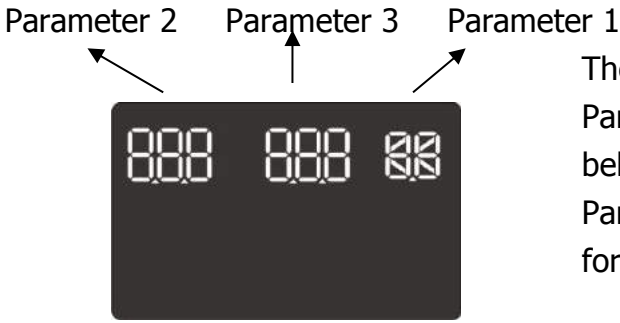

There are three parameters to set up the UPS.  
 Parameter 1: It's for program alternatives. Refer to below table.  
 Parameter 2&3: It's is the setting options or values for program.

● **01: Output voltage setting**

Interface	Setting
	<p><b>Parameter 3: Output voltage</b>                      You may choose the following output voltage:  <b>200:</b> presents output voltage is 200Vac  <b>208:</b> presents output voltage is 208Vac  <b>220:</b> presents output voltage is 220Vac  <b>230:</b> presents output voltage is 230Vac  <b>240:</b> presents output voltage is 240Vac (Default)</p>

● **02: Frequency Converter enable/disable**

Interface	Setting
	<p><b>Parameter 2 &amp; 3:</b> Enable or disable converter mode.                      You may choose the following two options:  <b>CF ENA:</b> converter mode enable  <b>CF DIS:</b> converter mode disable (Default)</p>

● **03: Output frequency setting**

Interface	Setting
	<p><b>Parameter 2 &amp; 3: Output frequency setting.</b>                      You may set the initial frequency on battery mode:  <b>BAT 50:</b> presents output frequency is 50Hz  <b>BAT 60:</b> presents output frequency is 60Hz                      If converter mode is enabled, you may choose the following output frequency:  <b>CF 50:</b> presents output frequency is 50Hz  <b>CF 60:</b> presents output frequency is 60Hz</p>

● **04: ECO enable/disable**

Interface	Setting
	<p><b>Parameter 3:</b> Enable or disable ECO function. You may choose the following two options:  <b>ENA:</b> ECO mode enable  <b>DIS:</b> ECO mode disable (Default)</p>

● **05: ECO voltage range setting**

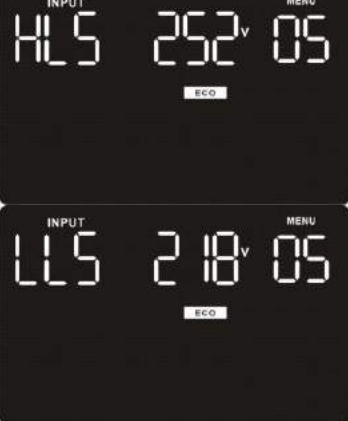
Interface	Setting
	<p><b>Parameter 2 &amp; 3:</b> Set the acceptable high voltage point and low voltage point for ECO mode by pressing Down key or Up key.  <b>HLS:</b> High loss voltage in ECO mode in parameter 2. For 200/208/220/230/240 VAC models, the setting range in parameter 3 is from +7V to +24V of the nominal voltage. (Default: +12V)  <b>LLS:</b> Low loss voltage in ECO mode in parameter 2. For 200/208/220/230/240 VAC models, the setting range in parameter 3 is from -7V to -24V of the nominal voltage. (Default: -12V)</p>

● **06: Bypass enable/disable when UPS is off**

Interface	Setting
	<p><b>Parameter 3:</b> Enable or disable Bypass function. You may choose the following two options:  <b>ENA:</b> Bypass enable  <b>DIS:</b> Bypass disable (Default)</p>

● **07: Bypass voltage range setting**

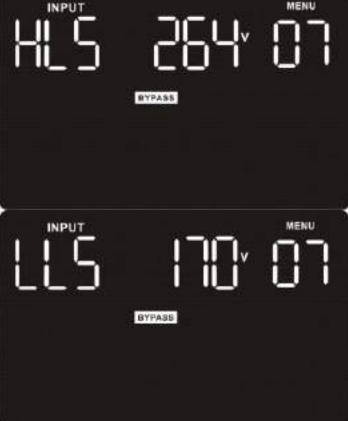
Interface	Setting
	<p><b>Parameter 2 &amp; 3:</b> Set the acceptable high voltage point and acceptable low voltage point for Bypass mode by pressing the Down key or Up key.  <b>HLS:</b> Bypass high voltage point  <b>230-264:</b> setting the high voltage point in parameter 3 from 230Vac to 264Vac. (Default: 264Vac)  <b>LLS:</b> Bypass low voltage point  <b>170-220:</b> setting the low voltage point in parameter 3 from 170Vac to 220Vac (Default: 170Vac)</p>

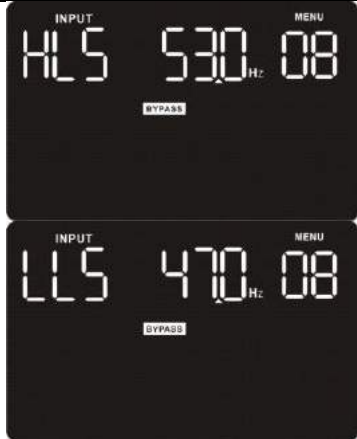

● **08: Bypass frequency range setting**

Interface	Setting
	<p><b>Parameter 2 &amp; 3:</b> Set the acceptable high frequency point and acceptable low frequency point for Bypass mode by pressing the Down key or Up key.</p> <p><b>HLS:</b> Bypass high frequency point  <b>51-55Hz:</b> setting the frequency high loss point from 51Hz to 55Hz(Default: 53.0Hz)</p> <p><b>LLS:</b> Bypass low Frequency point  <b>45-49Hz:</b> setting the frequency low loss point from 45Hz to 49HZ(Default: 47.0Hz)</p>

● **09: Programmable outlets enable/disable**

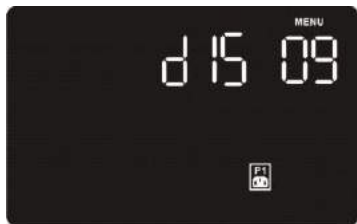
Interface	Setting
	<p><b>Parameter 3:</b> Enable or disable programmable outlets.</p> <p><b>ENA:</b> Programmable outlets enable  <b>DIS:</b> Programmable outlets disable (Default)</p>

● **10: Programmable outlets setting**

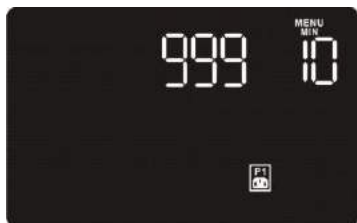
Interface	Setting
	<p><b>Parameter 3:</b> Set up backup time limits for programmable outlets.</p> <p><b>0-999:</b> setting the backup time limits in minutes from 0-999 for programmable outlets which connect to non-critical devices on battery mode. (Default: 999)</p>

● **11: Autonomy limitation setting**

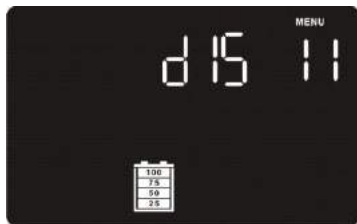
Interface	Setting
	<p><b>Parameter 3:</b> Set up backup time on battery mode for general outlets.</p> <p><b>0-999:</b> setting the backup time in minutes from 0-999 for general outlets on battery mode.</p> <p><b>DIS:</b> Disable the autonomy limitation and the backup time will depend on battery capacity. (Default)</p> <p><b>Note:</b> When setting as "0", the backup time will be only 10 seconds.</p>

● **12: Battery total AH setting**

Interface	Setting
	<p><b>Parameter 3:</b> Set up the total battery AH of the UPS.</p> <p><b>7-999:</b> setting the battery total capacity from 7-999 in AH. Please set the correct total capacity of battery if external battery bank is connected.</p>

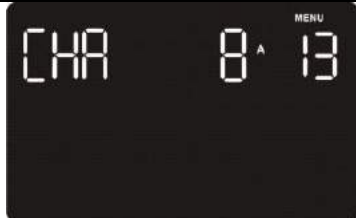

- **13: Charger maximum current setting**

Interface	Setting
	<b>Parameter 3:</b> Set up the charger maximum current. <b>1/2/4/6/8:</b> setting the charger maximum current 1/2/4/6/8 in Ampere. (Default: 8A) Note: the setting is only effective for the UPS with super charger

- **14: Charger Boost voltage setting**

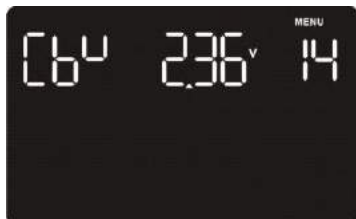
Interface	Setting
	<b>Parameter 3:</b> Set up the charger boost voltage. <b>2.25-2.40:</b> setting the charger boost voltage from 2.25 V/cell to 2.40V/cell. (Default: 2.36V/cell)

- **15: Charger Float voltage setting**

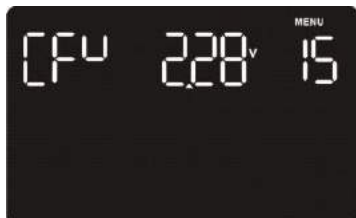
Interface	Setting
	<b>Parameter 3:</b> Set up the charger float voltage. <b>2.20-2.33:</b> setting the charger float voltage from 2.20 V/cell to 2.33V/cell. (Default: 2.28V/cell)

- **16: LCD display backlight setting**

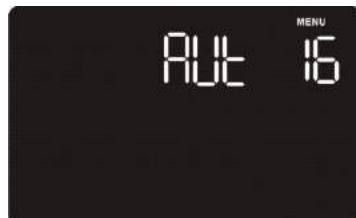

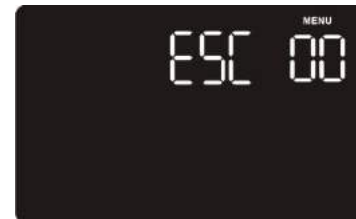

Interface	Setting
	Aon: LCD display backlight is on all the time. Aut: LCD display backlight will turn off after 60 seconds if no buttons are pressed. (Default setting)

- **00: Exit setting**

Interface	Setting
	Exit the setting mode.

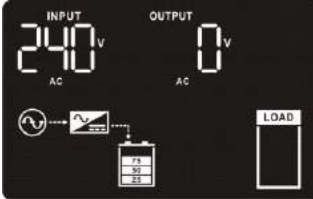

### Steps for setting programmable outlet ( White Coloured Outlets )

Procedure	LCD Screen
<p><b>Step 1:</b> Before entering setting mode, ensure the UPS is in either Bypass or Stand-by mode (off-charging) and make sure the battery is connected.</p>	
<p><b>Step 2:</b> Press and hold the "Select" button for 3 seconds to enter Setting mode.</p>	
<p><b>Step 3:</b> Press the "Up" button (ON/MUTE) to switch to "09" of program list. Then, press "Enter" button to enter value setting in parameter 2. Press the "Up" button to change the value to "ENA" to enable the programmable outlet function. Then, press "Enter" button again to confirm the setting.</p>	
<p><b>Step 4:</b> Press the "Up" button (ON/MUTE) again to switch to "10" of program list. Then, press "Enter" button to set up programmable outlet time. Press "Up" button to change the value of backup time according to your demand. Then, press "Enter" to confirm the setting.</p>	
<p><b>Step 5:</b> Press "Up" button (ON/MUTE) to switch to "00" of program list. Then, press "Enter" button to exit setting menu.</p>	
<p><b>Step 6:</b> Disconnect AC input and wait until the LCD display is off. The new setting will be activated when the UPS is turned on again.</p>	

### 3-6. Operating Mode Description

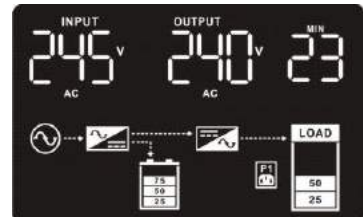
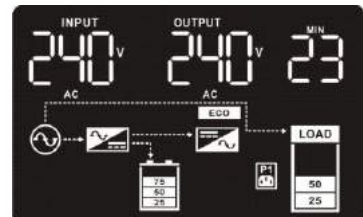

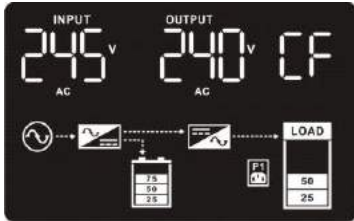
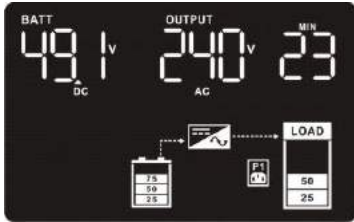
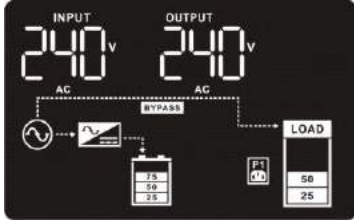
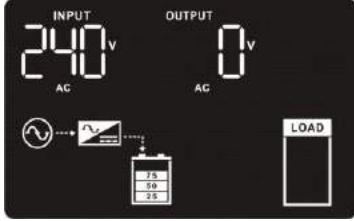
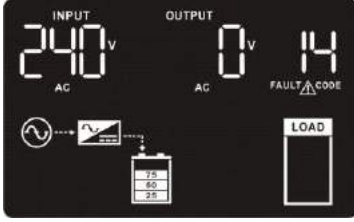



Operating mode	Description	LCD display
<p>Online mode</p>	<p>When the input voltage is within acceptable range, UPS will provide pure and stable AC power to output. The UPS will also charge the battery in online mode.</p>	
<p>ECO mode</p>	<p>When the input voltage is within setting range (<math>\pm 3\%V_o</math>), UPS will bypass voltage to output for energy saving. PFC and INVERTER are still active in this mode.</p>	

Frequency Converter mode	When input frequency is within 40 Hz to 70 Hz, the UPS can be set at a constant output frequency of 50 Hz or 60 Hz. The UPS will still charge the battery in this mode.	
Battery mode	When the input voltage is beyond the acceptable range or power failure and alarm is sounding 2 beeps every 30 seconds, UPS will backup power from the battery.	
Bypass mode	When input voltage is within acceptable range but UPS is in overload, UPS will enter bypass mode or bypass mode can be set by front panel. Alarm is sounding every 10 seconds.	
Standby mode	UPS is powered off without providing output power, but the battery is still being charged.	
Fault mode	The UPS is in fault mode when no output power is supplied from the UPS and the fault icon flashes on the LCD display. The UPS status information continues to be displayed on the screen.	

### 3-7. Faults Reference Code



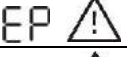
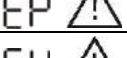
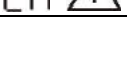

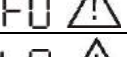
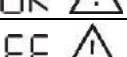
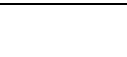



Fault event	Fault code	Icon	Fault event	Fault code	Icon
Bus start fail	01	x	Inverter output short	14	x
Bus over	02	x	Battery voltage too high	27	x
Bus under	03	x	Battery voltage too low	28	x
Inverter soft start fail	11	x	Over temperature	41	x
Inverter voltage high	12	x	Over load	43	OVER LOAD
Inverter voltage Low	13	x	Charger failure	45	x

### 3-8. Warning indicator

Warning	Icon (flashing)	Alarm
Low Battery		Sounding every second
Overload		2 short beeps every 2 seconds
Battery is not connected		2 short beeps every 2 seconds
Overcharge		Continuously sounding
Site wiring fault		2 short beeps every 2 seconds
EPO enable		2 short beeps every 2 seconds
Over temperature		Continuously sounding
Charger failure		Continuously sounding
Battery Fault		Continuously sounding (At this time, UPS is off to remind users of something wrong with battery)
Bypass Out Range		2 short beeps every 2 seconds
Bypass Frequency Unstable		2 short beeps every 2 seconds
Replace Battery		2 short beeps every 2 seconds
EEPROM error		2 short beeps every 2 seconds

## 4. Troubleshooting

If the UPS system does not operate correctly, please solve the problem by using the table below.

Symptom	Possible cause	Remedy
No indication and alarm even though the mains is normal.	The AC input power is not connected well.	Check if input power cord firmly connected to the mains.
	The AC input is connected to the UPS output.	Plug AC input power cord to AC input correctly.
The icon of  and the warning code EP are flashing on LCD display and alarm is sounding 2 short beeps every 2 seconds.	EPO function is activated.	Set the circuit in closed position to disable EPO function.
The icons of  and  are flashing on LCD display and alarm is sounding 2 short beeps every 2 seconds.	Line and neutral conductors of UPS input are reversed.	Rotate mains power socket by 180° and then connect to UPS system.
The icons of  and  are flashing on LCD display and alarm is sounding 2 short beeps every 2 seconds.	The external or internal battery is incorrectly connected.	Check if all batteries are connected well.
Fault code is shown as 27 on LCD display and alarm is continuously sounding.	Battery voltage is too high or the charger is fault.	Contact PowerShield.
Fault code is shown as 28 on LCD display and alarm is continuously sounding.	Battery voltage is too low or the charger is fault.	Contact PowerShield.
The icons of  and  are flashing on LCD display and alarm is sounding 2 short beeps every 2 seconds.	UPS is overload	Remove excess loads from UPS output.
	UPS is overloaded. Devices connected to the UPS are fed directly by the electrical network via the Bypass.	Remove excess loads from UPS output.
	After repetitive overloads, the UPS is locked in the Bypass mode. Connected devices are fed directly by the mains.	Remove excess loads from UPS output first. Then shut down the UPS and restart it.
Fault code is shown as 43 and the icon of  is lighting on LCD display. The alarm is continuously sounding.	The UPS shut down automatically because of overload at the UPS output.	Remove excess loads from UPS output and restart it.

<b>Symptom</b>	<b>Possible cause</b>	<b>Remedy</b>
Fault code is shown as 14 and alarm is continuously sounding.	The UPS shut down automatically because short circuit occurs on the UPS output.	Check output wiring and if connected devices are in short circuit status.
Fault code is shown as 01, 02, 03, 11, 12, 13 and 41 on LCD display and alarm is continuously sounding.	A UPS internal fault has occurred. There are two possible results: 1. The load is still supplied, but directly from AC power via bypass. 2. The load is no longer supplied by power.	Contact PowerShield
Battery backup time is shorter than nominal value	Batteries are not fully charged	Charge the batteries for at least 5 hours and then check capacity. If the problem still persists, consult PowerShield.
	Batteries defect	Contact your dealer to replace the battery.
Fault code is shown as 45 on LCD display. At the same time, alarm is continuously sounding.	The charger does not have output and battery voltage is less than 10V/PC.	Contact PowerShield.

## 5. Service

### WARRANTY CONDITION:

The standard warranty is TWO (2) years from the date of purchase. The standard PowerShield procedure is to replace the original unit with a factory refurbished unit. PowerShield will ship the replacement unit once the defective unit has been received by the service department, or cross ship upon the receipt of a valid credit card number. The customer pays for shipping the defective unit to PowerShield. PowerShield pays ground freight transportation costs to ship the replacement to the customer within Australian capital cities metro areas only.

### WARRANTY SERVICE PROCESS :

1. Review the problems discussed in the troubleshoot section of this manual to eliminate common problems.
2. Verify that no input/output circuit breaker are tripped. A tripped circuit breaker is the most common problem.
3. If the problem still persists, please call 1300-305-393 for technical support or fill in the form in PowerShield web page for on line technical support.  
Following details are needed for warranty claims.
  - Model number
  - Serial number
  - The date of purchase
4. Be prepare to troubleshoot the problem over the phone with PowerShield technical support.
5. If technical support found that the product is defective, then the technical support will issue a Return Material Authorization Number ( RMA # )
6. If the unit is under warranty, repair is free. If not there is a repair charge.
7. Pack the unit in its original packaging. Pack properly to avoid damage during transit. Damage sustained in transit is not covered under warranty.
8. Mark the RMA # on the outside of the package.
9. Return the defective unit by insured, prepaid carrier to the address given to you by Technical support.

## 6. Storage and Maintenance

### 6-1. Operation

Centurion series contains no user-serviceable parts. If the battery service life (3~5 years at 25°C ambient temperature) has been exceeded, the batteries must be replaced.

Please contact your dealer or visit PowerShield web site.

[www.powershield.com.au/support.php](http://www.powershield.com.au/support.php)



Be sure to deliver the spent battery to a recycling facility or ship it to your dealer in the replacement battery packing material.

### 6-2. Storage

Before storing, charge the UPS 5 hours. Store the UPS covered and upright in a cool, dry location. During storage, recharge the battery in accordance with the following table:

Storage Temperature	Recharge Frequency	Charging Duration
-25°C - 40°C	Every 3 months	1-2 hours
40°C - 45°C	Every 2 months	1-2 hours

## 7. Contacting PowerShield

Refer to the information provided at PowerShield internet site:

[www.powershield.com.au](http://www.powershield.com.au)

Or

Phone 1300 305 393



## 8. Specifications

MODEL		PSCE1000(L)	PSCE2000(L)	PSCE3000(L)			
<b>CAPACITY*</b>		1000 VA / 900 W	2000 VA / 1800 W	3000 VA / 2700 W			
<b>INPUT</b>							
Voltage Range	Low Line Transfer	160VAC/140VAC/120VAC/110VAC±5% ( based on load percentage 100% - 80 % / 80 % - 70 % / 70 - 60 % / 60 % - 0)					
	Low Line Comeback	175VAC/155VAC/135VAC/125VAC±5 %					
	High Line Transfer	300 VAC ± 5 %					
	High Line Comeback	290 VAC ± 5 %					
Frequency Range		40Hz ~ 70 Hz					
Phase		Single phase with ground					
Power Factor		≧ 0.99 @ 220-230 VAC (input voltage)					
THDi		≧ 5% @ 205-245VAC THDU < 1.6% @ input and full linear load condition with battery fully charged					
<b>OUTPUT</b>							
Output voltage		Nominal 240Vac Programmable to 200/208/220/230Vac					
AC Voltage Regulation (Batt. Mode)		± 1%					
Frequency Range (Synchronized Range)		47 ~ 53 Hz					
Frequency Range (Batt. Mode)		50 Hz ± 0.1 Hz or 60Hz ± 0.1 Hz					
Overload		100%~110%: audible warning 110%-130%: UPS shuts down in 5 minutes at battery mode or transfers to bypass mode when the utility is normal. 130%-140%: UPS shuts down in 30 seconds at battery mode or transfers to bypass mode when the utility is normal. >140%: UPS shuts down immediately at battery mode or transfer to bypass mode when the utility is normal.					
Current Crest Ratio		3:1					
Harmonic Distortion		≧ 2 % THD (Linear Load) ≧ 4 % THD (Non-linear Load)					
Transfer Time	AC Mode to Batt. Mode	Zero					
	Inverter to Bypass	4 ms (Typical)					
Waveform (Batt. Mode)		Pure Sinewave					
<b>EFFICIENCY</b>							
AC Mode		~ 90%					
Battery Mode		~86%	~88%	~90%			
<b>BATTERY</b>							
Standard Model	Battery Type	12 V / 9 AH	12 V / 9 AH	12 V / 9 AH			
	Numbers	3	6	6			
	Recharge Time	4 hours recover to 90% capacity (Typical)					
	Charging Current	1.5 A(max.)					
Long-run Model	Charging Voltage	41.0 VDC ± 1%	82.1 VDC ±1%				
	Battery Type & Numbers	Depending on the capacity of external batteries					
	Charging Current	1.0 A/2.0 A/4.0 A/6.0A/8.0 A(max.) (Selectable via LCD setting)					
	Charging Voltage	41.0 VDC ± 1%	82.1 VDC ±1%				
Charging Method		3 stage charging (CC -> CV -> FV)					
<b>PHYSICAL</b>							
Dimension, D X W X H (mm)		397 X 145 X 220		421 X 190 X 318			
Net Weight (kgs)		12.5	6.5	19	10.5	24.5	11.5
<b>ENVIRONMENT</b>							
Operation Humidity		20-90 % RH @ 0- 40°C (non-condensing)					
Noise Level		Less than 50dBA @ 1 Meter					
<b>MANAGEMENT</b>							
RS-232 or USB		Supports Windows® 2000/2003/XP/Vista/2008/7/8/10, Linux, Unix and MAC					
Optional SNMP		Power management from SNMP manager and web browser					

\* Derate capacity to 80% of capacity in Frequency converter mode and to 80% when the output voltage is adjusted to 200VAC or 208VAC.

\*\*Product specifications are subject to change without further notice.

**SERVICE / WARRANTY (Australia)**  
**(Tel) 1300-305-393**

**Warranty Conditions**

1. Power Shield product are warranted for certain specified period (see item 15 below) against failure due to faulty materials or workmanship from the invoice date from the Power Shield Store. Power Shields products are covered by a warranty in addition to all rights available to you by statute.
2. If, within the warranty period, the product does not meet the specification above and the product was installed and operated in accordance with Power Shield and Australian standards and procedures, then Power Shield will, correct any defects due to material or workmanship.
3. If the product has been modified, recalibrated, repaired, opened or tampered with in any way by the customer then its warranty will be void.
4. If the product has been damaged during transport then warranty will be void.
5. If product failed due to fire, earthquake, flood, direct lightning strike, terrorism, pollution, exposed under poison gas, and incorrect utility voltage then warranty will be void.
6. Batteries must be operated within the technical specification limits of the manufacturer and must be fully re-charged at least every three months during storage.
7. If Power Shield at its sole discretion determines that the product has failed, under Power Shield warranty conditions then Power Shield will at its option repair or replace the faulty unit
8. Power Shield will, at its sole discretion, replace the faulty product with an equal or equivalent model of a similar age and condition.
9. If the product, has failed due to reasons that Power Shield at its sole discretion, determines to be outside of warranty conditions, or is found to be not faulty then a minimum inspection and handling fee will be charged and also freight will be for the customer's account.
10. Blown fuses are usually as a result of overload and are not considered a warranty condition and a handling and inspection charge will apply as above
11. For hardwired products, larger than 3KVA, the warranty covers onsite repair for metro areas in capital cities only. For equipment installed in remote locations Power Shield may, at its sole discretion, request that the product be returned to a Power Shield service centre at the customer's cost,
12. Power Shield UPS products are not failsafe devices. Although well designed and manufactured, like all electrical, electronic and mechanical devices it has the potential to fail. This should be taken into consideration when designing any critical system
13. Subject to the applicable Law, in no event shall Power Shield Pty Ltd, it's officers, directors, affiliates or employees be liable for any form of indirect, special, consequential or punitive damages, arising out of the use, service or installation, of the products, whether such damages arise in contract or tort, irrespective of fault, negligence or strict liability or whether Power Shield Pty Ltd has been advised in advance of the possibility of such damages. Specifically, Power Shield Pty Ltd is not liable for any costs, such as lost profits or revenue, loss of equipment, loss of use of equipment, loss of software, loss of data, costs of substitution, claims by third parties, or otherwise.
14. Our products come with guarantees that cannot be excluded under the Australian Consumer Law. You are entitled to a replacement or refund for a major failure and compensation for any other reasonably foreseeable loss or damage. You are also entitled to have the products repaired or replaced if the products fail to be of acceptable quality and the failure does not amount to a major failure.
15. Warranty period commences from the date Power Shield invoices the goods  
ZapGuard Range: 1 year  
CompuGuard, SafeGuard, Defender, Commander, Centurion: 2 years  
Platinum Range: 1 year

**To claim a warranty our contact details are as follows**

Call Service on 1300-305-393

Or

Visit [www.powershield.com.au/rmaform/](http://www.powershield.com.au/rmaform/) to process an RMA

Or

Power Shield Pty Ltd (Head Office)  
U3, 205 Camboon Rd  
Malaga, WA 6090

Any claim for expenses must be provided to us in writing and should be sent to our office, detailed above.

**SERVICE / WARRANTY    New Zealand**

The standard warranty is TWO (2) years from the date of purchase. Please contact the reseller where the UPS was purchased to arrange a warranty return. Standard DYNAMIX procedure is to replace the original unit with a factory refurbished UPS if it cannot be repaired. DYNAMIX will ship the repaired/replacement unit once the defective unit has been received and tested by the service department. The customer pays all shipping charges to return the defective UPS to DYNAMIX. DYNAMIX pays the freight charges to ship the repaired/replacement UPS back to the customer within New Zealand.