

Eaton® T2235 Series Automatic Transfer Switch (eATS) ePDU®

Installation, Operations, and Maintenance Guide



Eaton and ePDU are registered trademarks of Eaton Corporation or its subsidiaries and affiliates. All other trademarks are property of their respective companies.

©Copyright 2009–2011 Eaton Corporation, Raleigh NC, USA. All rights reserved. No part of this document may be reproduced in any way without the express written approval of Eaton Corporation.

Special Symbols

The following are examples of symbols used on the UPS or accessories to alert you to important information:



RISK OF ELECTRIC SHOCK - Observe the warning associated with the risk of electric shock symbol.



CAUTION: REFER TO OPERATOR'S MANUAL - Refer to your operator's manual for additional information, such as important operating and maintenance instructions.



This symbol indicates that you should not discard waste electrical or electronic equipment (WEEE) in the trash. For proper disposal, contact your local recycling/reuse or hazardous waste center.

Table of Contents

1	INTRODUCTION	1
	Front Panel	1
	Rear Panel	1
	Dimensions	2
	Benefits	3
2	SAFETY	5
3	INSTALLATION	9
	Inspecting the Equipment	9
	Checking the Accessory Bag	9
	Cable Restraint Tray	9
	Before You Install	10
	Installing Optional Mounting Hardware	10
	Installing the T2235 Series eATS ePDU	11
4	OPERATION	15
	Indicators	15
	Circuit Breakers	16
	Power Outlets	16
	Auto-Transfer Primary to Secondary	16
	Optional EMI/RFI Filtering	16
	Surge Suppression	17
5	MAINTENANCE	19
	Preventive Maintenance	19
	Cleaning and Visual Inspection	19
	“No Output” Modes	19
	Servicing	19
6	SPECIFICATIONS	21
	Technical Specifications	21
	Online Specifications	22
7	SERVICE	29
8	WARRANTY	31

Table of Contents

Chapter 1 Introduction

Eaton® T2235 Series Automatic Transfer Switches (eATS) are Enclosure Power Distribution Units (ePDU®) that provide distribution of primary power to controlled devices. They are specially designed for switching non-phase synchronized AC power sources. The intelligent circuitry in a T2235 Series eATS ePDU monitors both primary and secondary power inputs.

If there is a problem with the primary power source, the eATS ePDU automatically transfers to the secondary power source. As soon as problems with the primary source are resolved, the eATS ePDU switches power back from the secondary to the primary source.

The T2235 Series eATS ePDU systems are all designed to operate at an input voltage range of 100–240V (12A, 16A, or 24A). All T2235 Series eATS ePDUs are single-phase models that operate at a frequency of 50/60 Hz.

Front Panel

The front panel provides LED indicators that provide operation status, such as power availability. The LED indicators also indicate whether the primary or secondary power source is in use.

Table 1 illustrates the front panel of a representative T2235 Series eATS ePDU model.

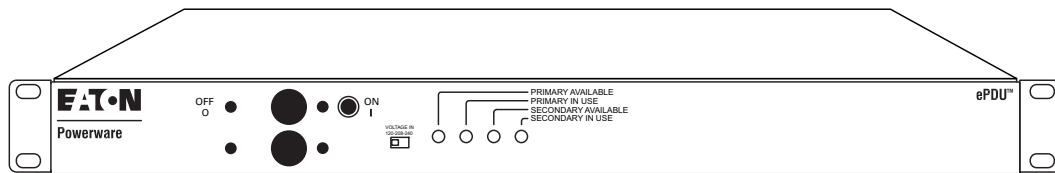

Figure 1. Front Panel (T2235-AB-NNBC20 model shown)

Rear Panel

Power input is provided through either an attached cable or a detached cable connected to a power inlet on the rear panel. Power output is through a variety of outlet configurations located on the rear panel.

Several types of input plugs are available on the T2235 Series eATS ePDUs, such as L5-20P, L5-30P, L6-20P, L6-30P, L5-15P, L5-20P, 5-15P, 5-20P, and IEC60320 C20.

Various output receptacles are available on the T2235 Series eATS ePDUs, such as NEMA 5-15R, NEMA 5-20R, NEMA L5-20R, NEMA L5-30R, NEMA L6-20R, NEMA L6-30R, IEC60309 C13, and IEC60309 C19.

Figure 2 illustrates the rear panel of a representative T2235 Series eATS ePDU.

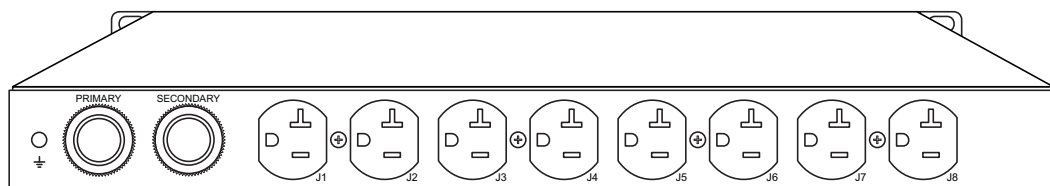

Figure 2. Rear Panel (T2235-A2-NNB09L model shown)

Dimensions

The T2235 Series eATS ePDUs are designed to mount in a standard 19-inch equipment rack with the following typical chassis dimensions:

- 482.6 mm (19.0") wide
- 44.5 mm (1.75") high
- 177.8–24.3 mm (7.0–9.5") deep



NOTE

There is currently one height exception. One custom-built T2235 Series eATS ePDU model with two rows of outlets (16 receptacles) is available. This model is 86.4 mm (3.4") high.



IMPORTANT

The depth of the model determines which optional cable restraint tray is appropriate for your T2235 Series eATS ePDU model.

Figure 3 illustrates an example of typical T2235 Series eATS ePDU model dimensions.

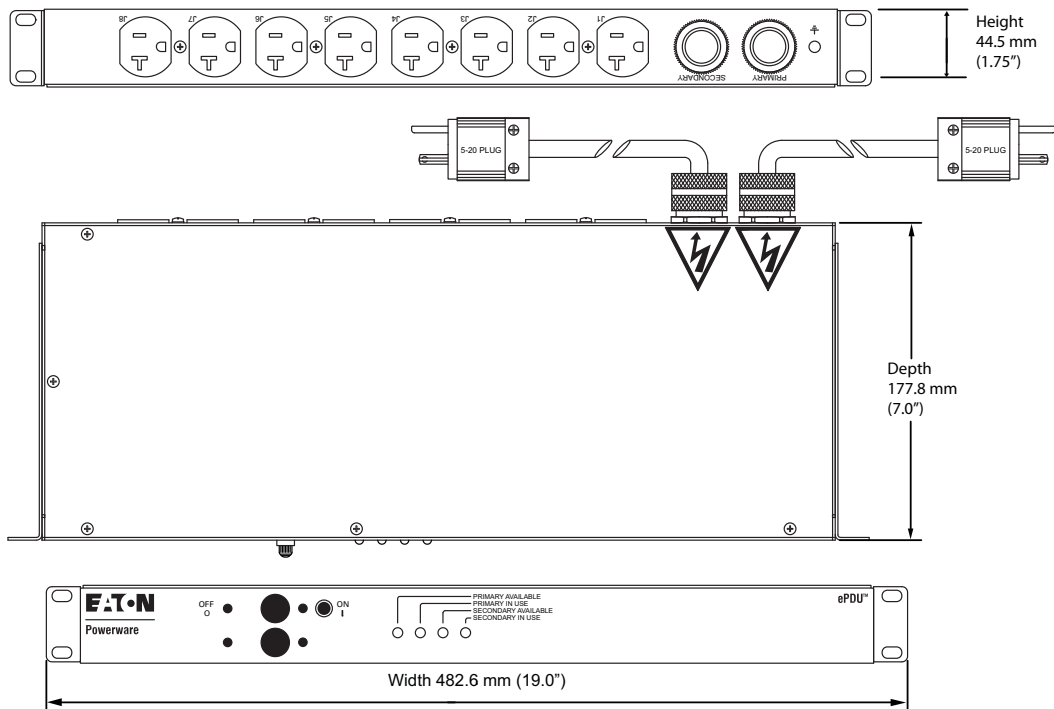

Figure 3. Typical Dimensions (T2235-A2-NNB09S model shown)

Benefits

The benefits of the T2235 Series eATS ePDUs are as follows:

- Provides dual power inputs and automatically selects the input source best suited to power-critical equipment.
- Meets Agency relay spacing requirements for out-of-phase switching up to 30A, while still performing fast enough to minimize transfer time.
- Provides power redundancy to equipment with one or two power supplies.
- Transfers power from the primary source to a secondary source automatically if there is a problem with the primary source of input power.
- Reverts power back to the primary source from the secondary source automatically when power is restored.
- Indicates status, such as power availability and output source, by lit LEDs.
- Simplifies load balancing by clearly labeled circuits.
- Meets systems global safety standards with Certified and Agency-approved.
- Includes domestic and International models.
- Supplies ruggedly constructed rackmount models.
- Mounts on a rack or in a cabinet that accepts standard 19" width spacing in a horizontal (1U) installation orientation.

Chapter 2 Safety

IMPORTANT SAFETY INSTRUCTIONS — SAVE THESE INSTRUCTIONS

This manual contains important instructions that you should follow during installation and maintenance of the Eaton Automatic Transfer Switch (eATS) Enclosure Power Distribution Unit (ePDU) models. Please read all instructions before operating the equipment and save this manual for future reference.

DANGER

This ePDU contains LETHAL VOLTAGES. All repairs and service should be performed by AUTHORIZED SERVICE PERSONNEL ONLY. There are NO USER SERVICEABLE PARTS inside the ePDU.

CAUTION

- To reduce the risk of fire or electric shock, install this ePDU in a temperature and humidity controlled, indoor environment, free of conductive contaminants. Ambient temperature must not exceed 45°C (113°F). Do not operate near water or excessive humidity (95% maximum).
 - To comply with international standards and wiring regulations, the total equipment connected to the output of this ePDU must not have an earth leakage current greater than 3.5 milliamperes.
 - For PERMANENTLY CONNECTED EQUIPMENT, a readily accessible disconnect device shall be incorporated in the building installation wiring.
 - For PLUGGABLE EQUIPMENT, the power outlet shall be installed near the equipment and shall be readily accessible.
-

Consignes de sécurité

CONSIGNES DE SÉCURITÉ IMPORTANTES — CONSERVER CES INSTRUCTIONS

Ce manuel contient des instructions importantes que vous êtes invité à suivre lors de toute procédure d'installation et de fonctionnement de la ePDU. Veuillez consulter entièrement ces instructions avant de faire fonctionner l'équipement et conserver ce manuel afin de pouvoir vous y reporter ultérieurement.

DANGER!

Cet ePDU contient des TENSIONS MORTELLES. Toute opération d'entretien et de réparation doit être EXCLUSIVEMENT CONFIEE A UN PERSONNEL QUALIFIE AGRÉÉ. AUCUNE PIÈCE RÉPARABLE PAR L'UTILISATEUR ne se trouve dans la ePDU.

 **ATTENTION!**

- Pour réduire les risques d'incendie et de décharge électrique, installer la ePDU uniquement à l'intérieur, dans un lieu dépourvu de matériaux conducteurs, où la température et l'humidité ambiantes sont contrôlées. La température ambiante ne doit pas dépasser 45 °C. Ne pas utiliser à proximité d'eau ou dans une atmosphère excessivement humide (95 % maximum).
 - Afin d'être conforme aux normes et règlements internationaux de câblage, le courant de fuite à la terre de la totalité du matériel branché sur la sortie de la ePDU ne doit pas dépasser 3,5 mA.
 - Afin de CONNECTER DE MANIÈRE PERMANENTE L'ÉQUIPEMENT, un dispositif de déconnexion aisément accessible doit être incorporé au câblage d'installation du bâtiment.
 - En ce qui concerne l'ÉQUIPEMENT ENFICHABLE, la prise d'alimentation doit être installée près de l'équipement et doit être facile d'accès.
-

Sicherheitswarnungen

WICHTIGE SICHERHEITSANWEISUNGEN — AUFBEWAREN

Dieses Handbuch enthält wichtige Hinweise, welche Sie bei der Installation und Wartung des ePDU beachten sollten. Bitte lesen Sie alle Anweisungen des Handbuches bevor Sie mit dem Gerät arbeiten. Bewahren Sie das Handbuch zum Nachlesen auf.

 **WARNUNG**

Die ePDU führt lebensgefährliche Spannungen. Alle Reparatur- und Wartungsarbeiten sollten nur von Kundendienstfachleuten durchgeführt werden. Die ePDU enthält keine vom Benutzer zu wartenden Komponenten.

 **VORSICHT!**

- Um die Brand- oder Elektroschockgefahr zu verringern, diese ePDU nur in Gebäuden mit kontrollierter Temperatur und Luftfeuchtigkeit installieren, in denen keine leitenden Schmutzstoffe vorhanden sind. Die Umgebungstemperatur darf 45 °C nicht übersteigen. Die ePDU nicht in der Nähe von Wasser oder in extrem hoher Luftfeuchtigkeit (max. 95 %) betreiben.
 - Um internationale Normen und Verdrahtungsvorschriften zu erfüllen, dürfen die an den Ausgang dieser ePDU angeschlossenen Geräte zusammen einen Erdableitstrom von insgesamt 3,5 Milliampere nicht überschreiten.
 - Für PERMANENT ANGESCHLOSSENE GERÄTE: In der Gebäudeverkabelung muss eine leicht zugängliche Trennvorrichtung enthalten sein.
 - Für GERÄTE MIT STECKERN: Die Steckdose muss sich in der Nähe des Geräts befinden und leicht zugänglich sein.
-

Advertencias de Seguridad

INSTRUCCIONES DE SEGURIDAD IMPORTANTES — GUARDE ESTAS INSTRUCCIONES

Este manual contiene instrucciones importantes que debe seguir durante la instalación y el funcionamiento de la ePDU. Por favor, lea todas las instrucciones antes de poner en funcionamiento el equipo y guarde este manual para referencia en el futuro.

PELIGRO

Este ePDU contiene VOLTAJES MORTALES. Todas las reparaciones y el servicio técnico deben ser efectuados SOLAMENTE POR PERSONAL DE SERVICIO TÉCNICO AUTORIZADO. No hay NINGUNA PARTE QUE EL USUARIO PUEDA REPARAR dentro de la ePDU.

PRECAUCIÓN

- Para reducir el riesgo de incendio o de choque eléctrico, instale este ePDU en un lugar cubierto, con temperatura y humedad controladas, libre de contaminantes conductores. La temperatura ambiente no debe exceder los 45°C. No trabaje cerca del agua o con humedad excesiva (95% máximo).
 - Para cumplir con los estándares internacionales y las normas de instalación, la totalidad de los equipos conectados a la salida de este ePDU no debe tener una intensidad de pérdida a tierra superior a los 3,5 miliamperios.
 - Para EQUIPO CONECTADO PERMANENTEMENTE, se debe incorporar un dispositivo de desconexión fácilmente accesible al cableado de la instalación del edificio.
 - Para EQUIPO ENCHUFABLE, la salida de alimentación debe estar instalada cerca del equipo y estar fácilmente accesible.
-

Chapter 3 Installation

The Eaton T2235 Series Automatic Transfer Switch (eATS) Enclosure Power Distribution Unit (ePDU) models have a 19" chassis composed of 16 gauge (Ga.), electrolytic galvanized (EG) or cold roll (CR) steel plate. The T2235 Series eATS ePDU can be mounted on a rack or in a cabinet that accepts standard 19" width spacing. The ePDUs are installed in a 1U orientation. Installation of a T2235 Series eATS ePDU is to be performed by qualified, trained technicians.

This chapter explains the following:

- Equipment inspection
- Setup and installation
- Front and back panel diagrams

Inspecting the Equipment

If any equipment has been damaged during shipment, keep the shipping cartons and packing materials for the carrier or place of purchase and file a claim for shipping damage. If you discover damage after acceptance, file a claim for concealed damage.

To file a claim for shipping damage or concealed damage: 1) File with the carrier within 15 days of receipt of the equipment; 2) Send a copy of the damage claim within 15 days to your service representative.

Checking the Accessory Bag

The following parts for installing the T2235 Series eATS ePDU are located in the accessory bag:

- (4) 10-32 X 1/2 Ohms Phillips head screws
- (4) #10 finishing nickel washer
- (4) #10 nylon washer

The following documentation is located in the shipping carton:

- User's guide

Cable Restraint Tray

Optional equipment is not shipped with aT2235 Series eATS ePDU. Optional equipment is shipped separately. If you ordered optional accessories, verify that the associated hardware is included when the option is delivered.

The depth of your model determines which optional cable restraint tray you need to order for your eATS ePDU:

- If your model is 228.6 mm or 241.3 mm (9" or 9.5") deep, use the KIT-CABLRES-01 cable tray.
- If your model is 177.8 mm (7.0") deep, use the KIT-CABLRES-03 cable tray.

KIT-CABLRES-01 Universal Cable Restraint System

The following parts for installing the optional cable restraint tray are located in the KIT-CABLRES-01 shipping carton:

- (1) Cable management tray (001-2211-2)
- (2) Mounting brackets (001-2212-2)
- (11) 6-32 X 1/4" black screws (035-1606)
- (12) Tie-wraps, 8" (010-0008)

KIT-CABLRES-03 Universal Cable Restraint System

The following parts for installing the optional cable restraint tray are located in the KIT-CABLRES-03 shipping carton:

- (1) Cable management tray (001-2211-2)
- (2) Mounting brackets (001-2233-2)
- (11) 6-32 X 1/4" black screws (035-1606)
- (12) Tie-wraps, 8" (010-0008)

Before You Install

Consider where you will locate the T2235 Series eATS ePDU model. These models are typically mounted at the bottom or rear of the equipment cabinet. This location is convenient because heavy power cables are usually routed at the bottom of the cabinet.

Ensure that you select a location with proper spacing. The T2235 Series eATS ePDUs typically require 44.5 mm (1.75") of vertical mounting space and extend 177.8 mm to 241.3 mm (7–9.5") into the mounting rack of the cabinet. Eaton recommends mounting the ePDU as close as possible to the equipment it controls.

Determine if you need additional weight support. The ePDU is designed to support its own weight only. Eaton recommends using cable management and support brackets, such as the KIT-CABLRES-01 Universal Cable Restraint System.

Consider temperature specifications in the installation site. Ambient temperature at the installation site should not exceed 35°C (95°F). Relative humidity should remain below 95%, noncondensing.

CAUTION

The ePDU uses unpainted mounting brackets that serve as grounding to the rack. No separate ground connection is necessary. For proper grounding, the electrical connection between the T2235 Series eATS ePDU and the cabinet or rack must be secure.

Installing Optional Mounting Hardware

For T2235 Series eATS ePDU models, optional mounting hardware is available, including attachable cable restraint trays.

Cable Restraint Tray

To install the cable restraint tray:

1. Place the ePDU on a flat, stable surface.
2. Slide the cable restraint tray onto the ePDU. Align the holes in the tray bracket with the screw holes on the ePDU.
3. Secure the cable restraint tray to the ePDU with the tray mounting screws (supplied).
4. Secure the ePDU with attached cable restraint tray to the rack rails with the ePDU mounting screws (supplied).
5. This procedure is completed.

Figure 4 shows an example cable restraint tray installed on an eATS ePDU in a rack.

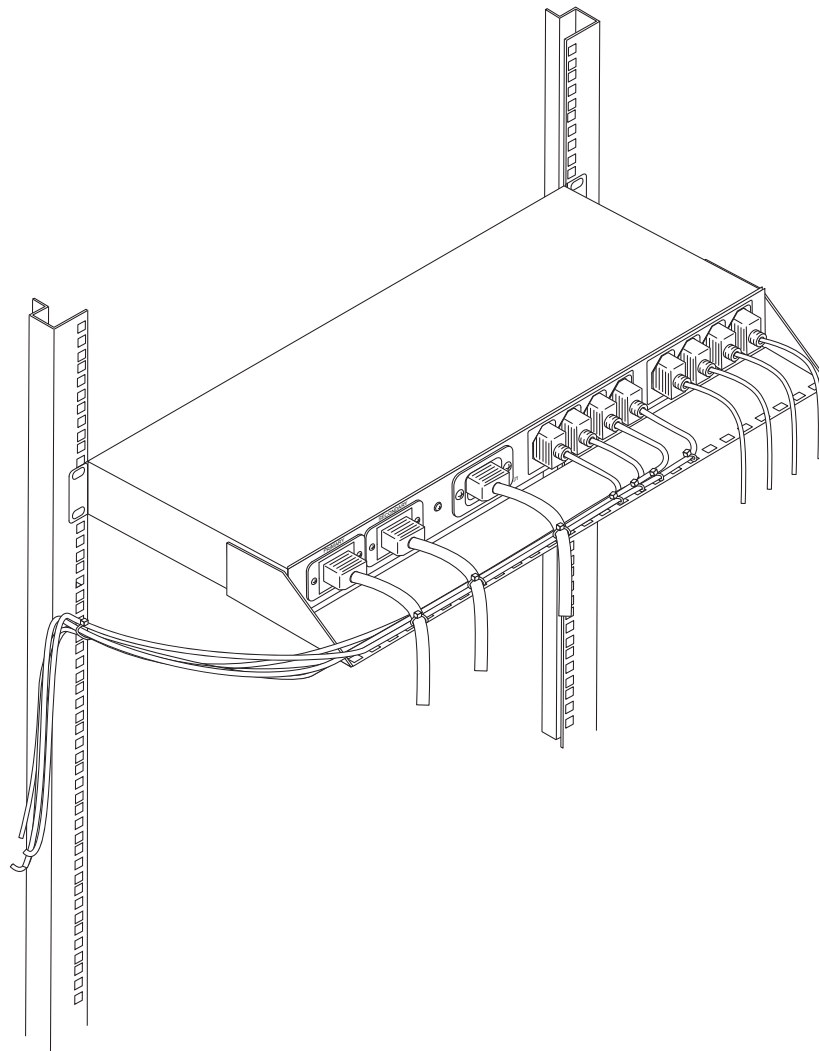

Figure 4. Cable Restraint Tray Installation

Installing the T2235 Series eATS ePDU

⚠ CAUTION

For PLUGGABLE EQUIPMENT, the power outlet you intend to use must be near the equipment and readily accessible.

⚠ CAUTION

Confirm that the equipment connected to the ePDU does not exceed the ePDU's capacity. Each circuit breaker is rated at 16A/200–240 Vac, with a 12A per segment maximum rating.



IMPORTANT

The ePDUs have two separate receptacle groups. The ePDU segments are protected separately by circuit breakers on the front panel.

To install the ePDU:

1. If optional circuit breakers are installed, verify that each circuit breaker on the ePDU is in the OFF position. The indicator LED should be off.
2. Plug the equipment power cords into the ePDU output receptacles. Distribute the load evenly between the segments.
3. Secure the power cords to the cord retention bracket with the supplied tie wraps.
4. If your model uses a detached power cable assembly, connect the power cable(s) to the rear panel of the ePDU.
5. Plug the ePDU power cord(s) into a power outlet. The indicator LED illuminates.
6. If optional circuit breakers are installed, turn each circuit breaker to the ON position.
7. This procedure is completed



NOTE

If power to the ePDU is interrupted, check each circuit breaker and reset if necessary.

Power Cable Cautions

The power cable assembly connects to the T2235 Series eATS ePDU on the rear panel and the other end of the cable assembly connects to the main power supply.

Eaton offers power cable assemblies with plug configurations for most countries. Most T2235 Series eATS ePDU models have an attached power cable and plug, but some have detached cords.



CAUTION

If the plug on the power supply cord is to be used as the disconnect device, the power outlet should be near the equipment and should be easily accessible.

Power Source Caution

Before applying primary power to the T2235 Series eATS ePDU, verify that the power source has the correct voltage and current for proper operation of the T2235 Series eATS ePDU model you are installing. Visit www.eaton.com/ePDU for technical specification data sheet information for your model.



CAUTION

Before installing T2235 Series eATS ePDU systems purchased with optional breakers, verify that the breakers are in the OFF position.

Branch Circuit Protection Caution

Circuit breakers are not provided on all models; breakers are optional. Models purchased with optional circuit breakers use one of the following breaker types:

- One 1-Pole circuit breaker on the front panel
- One 2-Pole circuit breaker as both an ON/OFF switch and overcurrent protection device

**CAUTION**

If a supplementary protector is used in the ePDU instead of a listed circuit breaker, additional branch circuit protection will be required down-line from the power source to the ePDU.

Chapter 4 Operation

This chapter describes operation of Eaton T2235 Series Automatic Transfer Switch (eATS) Enclosure Power Distribution Unit (ePDU) models, including the following:

- Indicators, circuit breakers, and power outlets
- Auto-transfer of primary input power to secondary input power
- Electromagnetic interference/radio frequency interference (EMI/RFI) filtering option
- Surge suppression

Indicators

The T2235 Series eATS ePDU models use six LED indicators to convey the following:

- Indicates that power is enabled (ON)
- Indicates that power is disabled (OFF)
- Identifies whether an input power source is available
- Indicates which power source is being utilized

Table 1 describes the T2235 Series eATS ePDU LED status indicators.

Table 1. LED Status Indicators

Indicator	Description
ON	Blue LED indicates main power is provided to the outlets. Unlit LED indicates the main power is OFF.
OFF	Unlit LED indicates the main power is ON.
Primary Available	Green LED indicates power is available from the primary source. Unlit LED indicates the primary input power source is unavailable.
Primary in Use	Green LED indicates power to the outlets is from the primary source. Unlit LED indicates that power to the outlets is not from the primary source.
Secondary Available	Green LED indicates power is available from the secondary source. Unlit LED indicates the secondary input power source is not available.
Secondary in Use	Green LED indicates power to the outlets is from the secondary source. Unlit LED indicates that power to the outlets is not from the secondary source.

Figure 5 shows the front panel view of a representative T2235 Series eATS ePDU model with each LED indicator identified.

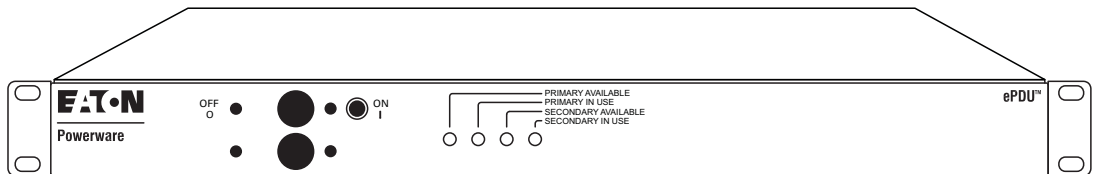

Figure 5. Front Panel (T2235-AB-NNBC20 model shown)

Circuit Breakers

Circuit breakers protect the power controller and all devices connected to it from fault conditions, such as a short circuit or an overload. Circuit breakers are optional for ePDUs with less than 30A input. However, circuit breakers are mandatory for ePDUs with 30A input or greater.



IMPORTANT

If a supplementary protector is used in the ePDU instead of a listed circuit breaker, additional branch circuit protection is required down-line from the power source to the ePDU.

Power Outlets

All outlets are on the rear panel. Power is available to the switched outlets after the main power is either connected or the optional breaker is set to the ON position.

Auto-Transfer Primary to Secondary

Firm drop-out voltage points allow a transfer before an undervoltage affects equipment operation.

Table 2 shows the transfer voltage ranges.

Table 2. Transfer Voltage Ranges

Nominal Voltage	Drop-Out Voltage	Pull-In Voltage
120V	90V	103V
208V	182V	195V
240V	197V	210V

Sources do not need to be phase synchronized. Source transfer time is less than 30 ms. (The front panel LEDs indicate which sources are available and selected at the output, as shown in Figure 5.)

Optional EMI/RFI Filtering

EMI/RFI Filtering (Option 3)

Power filtering reduces the effects of EMI or RFI. This type of “noise” can be introduced from many sources, inside or outside your facility. The filtering is bi-directional, so it helps prevent emissions from connected equipment. Select “F” in Option 3 to include EMI/RFI Filtering or “N” to exclude it.

Table 3 shows EMI Filter Specifications.

Table 3. EMI Filter Specifications

Specification	Common mode insertion loss	Differential mode insertion loss
	Line-to-Ground in 50 ohm circuit	Line-to-Line in 50 ohm circuit
Current rating	20A	20A
MHz	dB	dB
240 V	197V	210V

* The rated voltage is 120/250 Vac. The operating frequency is 50/60 Hz.

Figure 6 shows the EMI Filtering diagram.

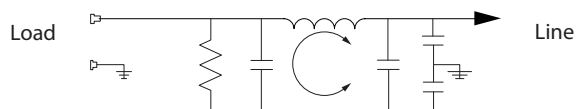

Figure 6. Filtering Diagram

Surge Suppression

Some T2235 Series eATS ePDU models provide line-to-neutral metal oxide varistors (MOVs), and some models provide line-to-line MOVs as delivered from the factory. See Chapter 6, “Specifications” on page 21 for more information.

Table 4 shows specification data for Surge Protection Devices (SPD), formerly referred to as Transient Voltage Surge Suppressors (TVSS).

Table 4. SPD Specification Data

Specification	Rating
Continuous DC Voltage	360 Vdc
Maximum DC Leakage	200 mA
Low Varistor Voltage Limit	389 Vdc
High Varistor Voltage Limit	453 Vdc
Nominal Varistor Voltage	424 Vdc
Current For Varistor Voltage	1mA
Maximum Clamp Voltage 8x20 ms	680V
Maximum Clamp Voltage Test Current	100A
Peak Current Rating (1 Pulse) 8x20 ms	10000A
Peak Current Rating (2 Pulse) 8x20 ms	6500A
Energy Rating (10x100 ms)	325J
Energy Rating (8x20 ms)	325J
Capacitance	970 pF
Impulse Response Time	50 ns

Chapter 5 Maintenance

The Eaton T2235 Series Automatic Transfer Switches (eATS) Enclosure Power Distribution Unit (ePDU) models are constructed of high quality components and can be expected to provide trouble-free performance for extended periods. No adjustment or alignment procedures are required.

Maintenance of the T2235 Series eATS ePDUs should be performed by qualified, trained technicians.

Preventive Maintenance

No periodic maintenance is required.

Cleaning and Visual Inspection

Dust and lint should be removed from the T2235 Series eATS ePDUs by brushing, blowing, or vacuuming. Check for loose external connections or evidence of damage to the equipment.

“No Output” Modes

A circuit breaker may or may not trip when a “No Output” failure mode occurs for a T2235 Series eATS ePDU.

Circuit Breaker Tripped

If the correct power is available from the main power source, a tripped circuit breaker can be caused by the following:

- Faulty circuit breaker
- Excessive load
- Short in the power controller

Circuit Breaker Not Tripped

If the correct power is available from the main power source, and a circuit breaker is not tripped, the failure can be caused by the following:

- Bad cable connections
- Improper remote connection
- Circuit board failure

Servicing



IMPORTANT

Do not remove the cover of this product. There are no user-serviceable parts in this product.

Refer all servicing to qualified service personnel. The T2235 Series eATS ePDUs are sealed with warranty labels that are not to be broken. If these seals are broken, the unit will automatically be considered out of warranty. See Chapter 8, “Warranty” on page 31 for more information.

For any problem directly related to systems, such as a faulty circuit breaker, the unit must be returned to Eaton Corporation under a Return Material Authorization (RMA) number. See Chapter 7, “Service” on page 29 for more information, or visit www.eaton.com/ePDU.

Chapter 6 Specifications

This chapter lists specifications that are applicable for all Eaton T2235 Series Automatic Transfer Switch (eATS) Enclosure Power Distribution Unit (ePDU) models. This chapter also describes online access to detailed model specifications, mechanical engineering diagrams, and additional documentation, such as product feature, options, and support.

Technical Specifications

This section includes technical specifications that apply for all T2235 Series eATS ePDUs, including mechanical and environmental specifications, input and output specifications, and safety standards.

Mechanical Specifications

Table 5 provides mechanical specifications for all T2235 Series eATS ePDUs.

Table 5. Mechanical Specifications

Width	482.6 mm (19.0")
Height	44.5 mm (1.75")
Chassis Depth	177.8–24.3 mm (7.0"–9.5")
Approximate Shipping Weight	6.8 kg (15 lb.)
Mounting	Rackmount
Finish	Powder coat black with white silk screen or zinc plated gold with black silk screen
Rack Sizing	Standard 19" rack

Environmental Specifications

Table 6 provides environmental specifications for all T2235 Series eATS ePDUs.

Table 6. Environmental Specifications

Operating Temperature (Room Ambient)	0°C to 50°C (32°F to 122°F)
Shipping and Storage Temperature	-25°C to 70°C (-13°F to 158°F)
Interior ePDU Temperature Maximum	70°C (158°F) maximum
Relative Humidity	5–90% noncondensing
Operating Altitude	Up to 3,048m (10,000 ft) above sea level (derated for higher altitude applications)
Shipping and Storage Altitude	Up to 12,200m (40,000 ft) above sea level

Input and Output Specifications

Table 7 provides electrical input and output specifications for all T2235 Series eATS ePDUs.

Table 7. Input and Output Specifications

Input Frequency	50/60 Hz \pm 3 Hz
Input Voltage Tolerance	+6% / -10%
Input Power Range	1.4kW–5kW
Output Frequency	50/60 Hz
Output Voltage Tolerance	+6% / -10%
Output Voltage Range	100–240V (12A, 16A, or 24A)

Safety Standards

Most of the Eaton T2235 Series eATS ePDU are UL listed and have been tested and approved to U.S. and Canadian (Bi-National) Standard for Safety of Information Technology Equipment, CSA C22.2 No 60950 Third Edition, dated December 1, 2000.

Online Specifications

The Eaton ePDU Web site (www.eaton.com/ePDU) provides online access to technical specifications, mechanical engineering diagrams, product features, options, and support resources. Individual data sheet specification documents are available for all T2235 Series eATS ePDU products.

Figure 7 illustrates a portion of a data specification sheet for a representative T2235 Series eATS ePDU.

EATON
Powering Business Worldwide

Close Window

See All Eaton eATS ePDUs Documentation
Back to Family Page

Contact me about this ePDU

PIWATSL520004

Top Rated

General

Description	EATS, 1U, L5-20P, 5-20 OUTPUT
List Price	\$699
Function	AT Interact with an eATS ePDU

Drawing

Physical

Dimensions (H x W x D, inches)	Box: 23 x 13.5 x 6 Unit: 1.75 x 19 x 7
Mounting Style	Horizontal

Input

Max kW	1.92
Plug	L5-20P
Cable Length (ft)	9
Voltage	1-Phase 110-125
Current	16A
Phase	Single Phase

Figure 7. Example Online Data Sheet Specification

Country Selections (Optional)

To select a country to access the EATON ePDU Main page in different languages (see Figure 8):

1. Select www.ePDU.com/country. The EATON EPDUS - COUNTRY SELECTION page displays.

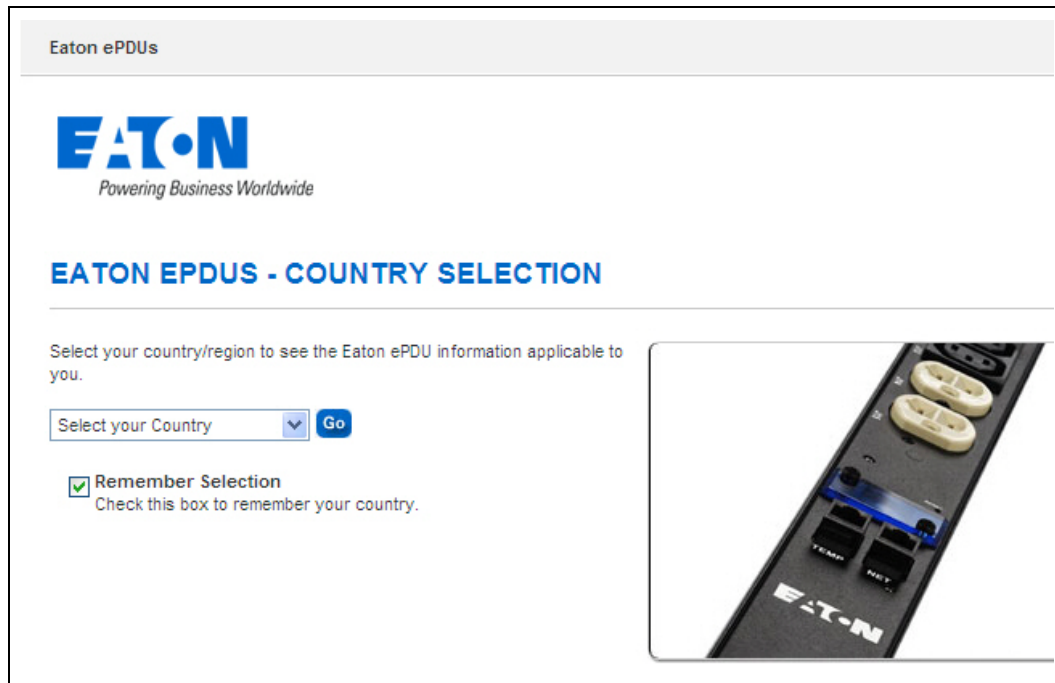

Figure 8. Country Selection

2. Select a country name in the drop-down list and click **Go**.
3. The EATON ePDU Main page displays (see Figure 9).



NOTE

The country name you select determines the language that displays on the Eaton ePDU Web site. Enabling the **Remember Selection** feature allows you to skip the Country Selection page in the future and display the Eaton ePDU Web site (www.eaton.com/ePDU) for the country you first selected. This feature is enabled by default. To disable this feature, click the checkbox to remove the check.

Viewing in the Main T2235 Series eATS ePDU Family Page

To view the EATON EPDU Main page:

1. Select www.eaton.com/ePDU. The EATON EPDU Main page displays (see Figure 9).
 - To search for a specific T2235 product line or model, go to “Using the ePDU Product Part Number Search Wizard” on page 25.
 - To create specific search criteria to search for T2235 products by specific qualities, go to “Using the ePDU Product Function Search Wizard” on page 26.
 - To browse for a model from a list of options, go to “Using the ePDU Browse Feature” on page 27.

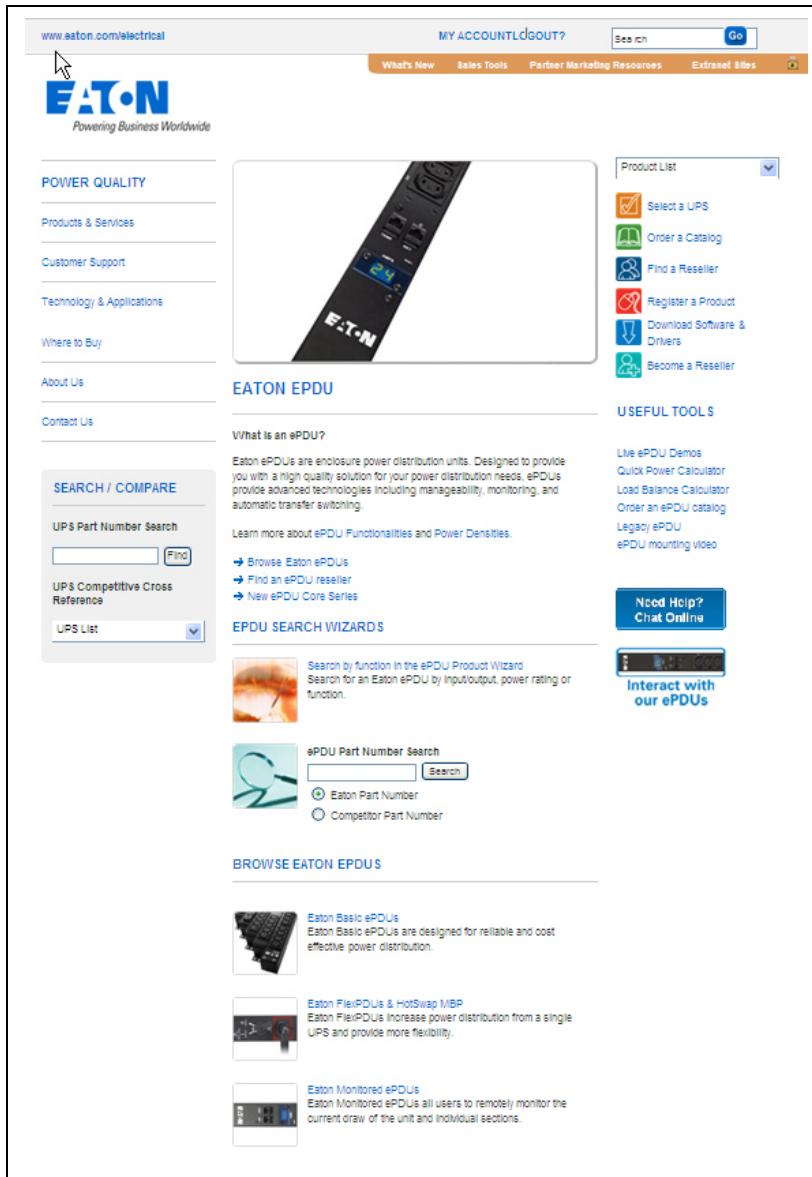

Figure 9. EATON EPDU Main Page

Using the ePDU Product Part Number Search Wizard

To use the EPDU PRODUCT WIZARD to view T2235 Series eATS ePDU technical specifications online (see Figure 10):

1. From the EATON EPDU Main page under EPDU SEARCH WIZARDS, click the **Eaton Part Number** or **Competitor Part Number** radio button.
2. Enter a partial or complete part number in the **ePDU Part Number Search** field. The adjacent **Search** button name changes to **Show <quantity> results**. Click the button to view the search results.



NOTE If you select the **Competitor Part Number** radio button and the competitor's part number is not recognized when you attempt to search, the following message displays: The Part Number entered does not match with our database. Please contact an ePDU reseller in your area for assistance.

3. For an Eaton ePDU part number search, the EPDU PRODUCT WIZARD window displays the search results. Click the blue highlighted part number link in the first column to view a specific online technical specification sheet. Otherwise, click **Close Window** to exit (see Figure 10).

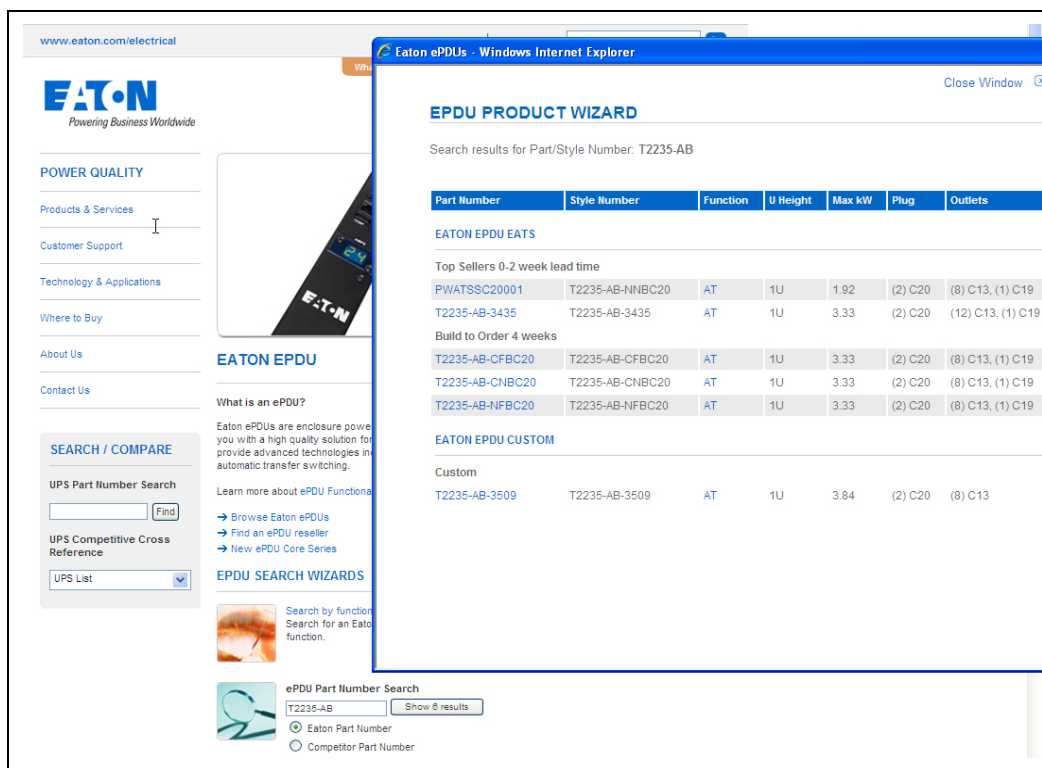

Figure 10. Eaton ePDU Product Part Number Search Wizard

Using the ePDU Product Function Search Wizard

To use the EPDU PRODUCT WIZARD to view specifications online (see Figure 11):

1. From the EATON EPDU Main page under EPDU SEARCH WIZARDS, click the **Search by function in the ePDU Product Wizard** link.
2. Either accept the default or select a new value from the drop-down lists for the **Input Plug, Output Receptacle, Power Rating, or Function**. The screen redisplay with the ePDU models that match the search criteria.

NOTE If you make incompatible selections, the following message displays: The ePDU solution you have requested is either a custom build or is not a possible match. Please contact an ePDU reseller in your area for assistance.

3. Click the blue highlighted part number link in the first column to access a specific T2235 Series eATS ePDU technical specification sheet online. Otherwise, click **Close Window** to exit.

EPDU PRODUCT WIZARD

Please use the following filters to find the ePDU that best fits your needs:

Input Plug

Output Receptacle

Power Rating

Function

Part Number	Style Number	Function	U Height	Max kW	Plug	Outlets
EATON FLEXPDU & HOTSWAP MBP						
Top Sellers 0-2 week lead time						
EFLXJ3000R-PDU1UIEC	68438	BA	1U	3.33	C20	(12) C13, (1) C19
EFLXL1500R-PDU1U	58015	BA	1U	1.44	5-15P	(12) 5-15R, (1) C19
EFLXL2000R-PDU1U	58020	BA	1U	1.92	5-20P	(12) 5-20R
EFLXL2000R-PDU1UL	58021	BA	1U	1.92	5-20P	(5) L5-20R
EHBPL1500R-PDU1U	58115	BA	1U	1.44	5-15P	(6) 5-15R
EHBPL2000R-PDU1U	58120	BA	1U	1.92	5-20P	(6) 5-20R
EHBPL3000R-PDU1U	58130	BA	1U	2.88	L5-30P	(5) 5-20R
EATON EPDU EATS						
Top Sellers 0-2 week lead time						
PWATSL520004	T2235-A2-NNB09L	AT	1U	1.92	(2) L5-20P	(8) 5-20R
PWATSL530005	T2235-C2-CNB09L	AT	1U	2.88	(2) L5-30P	(8) 5-20R
PWATSL530007	T2235-3369	AT	1U	2.88	(2) L5-30P	(1) L5-30R
PWATSL630006	T2235-F3-CNB09L	AT	1U	4.992	(2) L6-30P	(12) C13
PWATSL630008	T2235-3358	AT	1U	4.992	(2) L6-30P	(1) L6-30R

Figure 11. Eaton ePDU Product Function Search Wizard

Using the ePDU Browse Feature

To use the ePDU Browse Feature to view online specifications:

1. From the main ePDU page under the BROWSE EATON EPDUS list, click the **Eaton Automatic Transfer Switches** link (see Figure 12). The EATON EATS EPDUS main page displays.

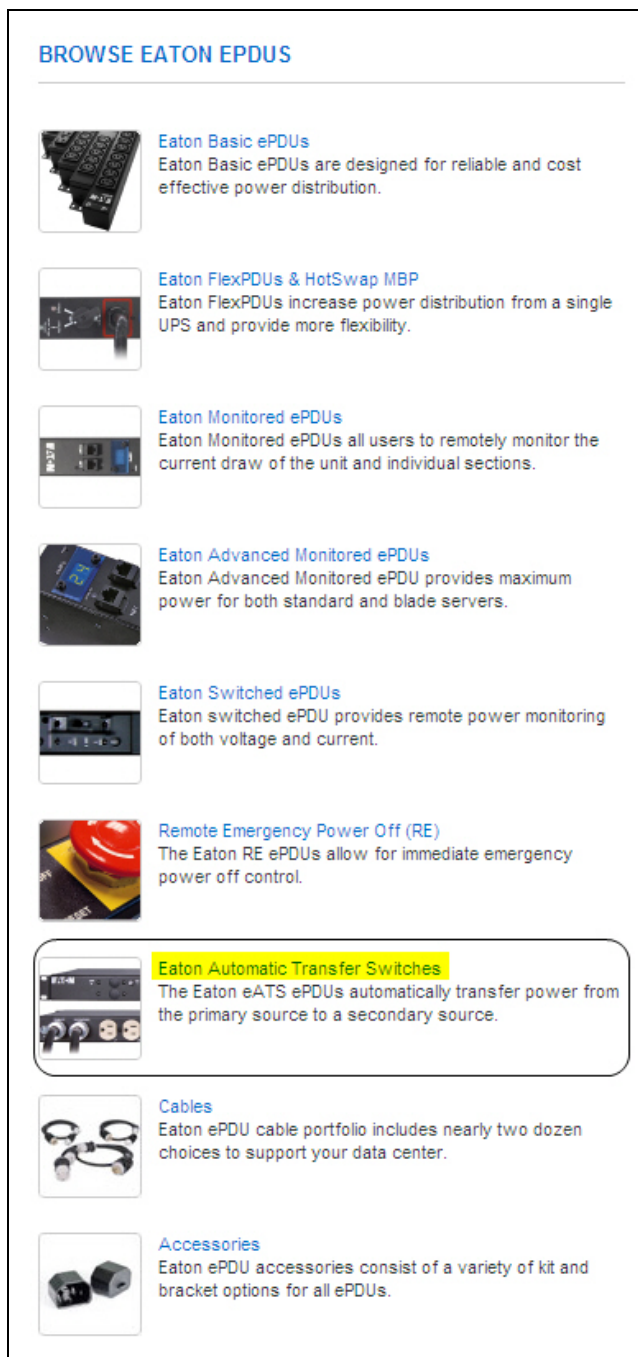

Figure 12. Eaton ePDU Browse Feature Selection

2. From the EATON EATS EPDUS Main page, perform one of the following:
 - Click the **ePDU Product Wizard** button. In the EPDU PRODUCT WIZARD window, enter search criteria to view a list of eATS ePDUs that meet that criteria (see Figure 11 on page 26).
 - Click the **Technical Specs** tab to see a comprehensive list of all eATS ePDUs in the product line (see Figure 13).

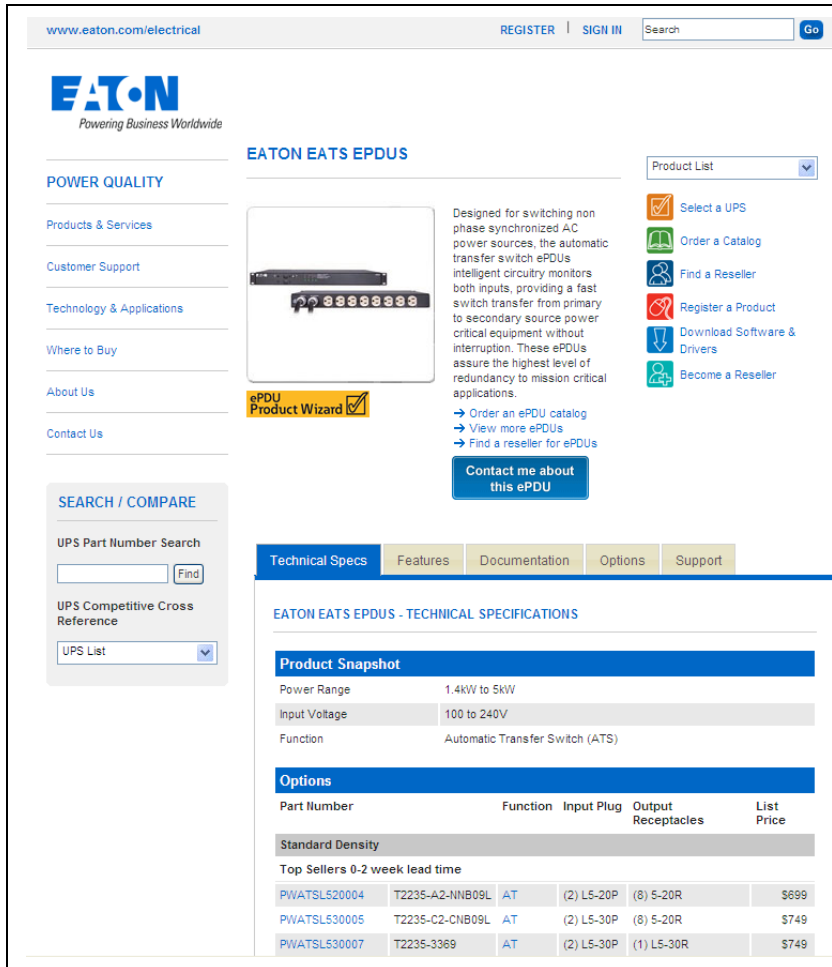

Figure 13. EATON EATS EPDUS Main Page

3. Browse the list for your selection. Click the blue highlighted part number link in the first column to access a specific T2235 Series eATS ePDU technical specification data sheet (see Figure 13).

NOTE You can view the document online, open or save the engineering diagram to your PC, or convert the page to a PDF and print the data sheet specification locally.

4. When you finish, return to the EATON EATS EPDUS Main page either to end this session, or to select a tab for features, documentation, options, or support resources.
5. This procedure is completed.

Chapter 7 Service

If you have any questions or problems with the Eaton Enclosure Power Distribution Unit (ePDU) Automatic Transfer Switches (eATS), call your Local Distributor or the Help Desk at one of the following telephone numbers and ask for an ePDU technical representative.

United States: **1-800-356-5737**
All other countries: **Call your local service representative**

Please have the following information ready when you call the Help Desk:

- Model number
- Serial number
- Version number (if available)
- Date of failure or problem
- Symptoms of failure or problem
- Customer return address and contact information

If repair is required, you will be given a Returned Material Authorization (RMA) Number. This number must appear on the outside of the package and on the Bill Of Lading (if applicable). Use the original packaging or request packaging from the Help Desk or distributor. Units damaged in shipment as a result of improper packaging are not covered under warranty. A replacement or repair unit will be shipped, freight prepaid for all warranted units.

For critical applications, immediate replacement may be available. Call the Help Desk for the dealer or distributor nearest you.

Chapter 8 Warranty

Two-Year Limited Warranty (USA and Canada)

Eaton Enclosure Power Distribution Units (ePDUs)

WARRANTOR: The warrantor for the limited warranties set forth herein is Eaton Corporation, an Ohio Corporation Company ("Company").

RACKMOUNTED LIMITED WARRANTY: This limited warranty (this "Warranty") applies only to the original End-user (the "End-user") of any Eaton Rackmounted Power Distribution Units (the "Product") purchased on or after June 1, 2004, and cannot be transferred. This Warranty applies even in the event that the Product is initially sold by Company for resale to an End-user.

LIMITED WARRANTY PERIOD: The period covered by this Warranty for the Product installed [and currently located] in the fifty (50) United States, the District of Columbia and Canada is twenty-four (24) months from the date of purchase.

WHAT THIS LIMITED WARRANTY COVERS: The warrantor warrants that the Product (the "Warranted Item") is free from defects in material and workmanship. If, in the opinion of Company, a Warranted Item is defective and the defect is within the terms of this Warranty, Company's sole obligation will be to repair or replace such defective Warranted Item (including by providing service, parts and labor, as applicable), at the option of Company.

PROCEDURES FOR REPAIR OR REPLACEMENT OF WARRANTED ITEMS:

Standard Product: Defined as ePDU product with the product number sequence PWxxxxxxxxx, (whereas x can be any value). The Warranted item will be replaced by the Company.

Custom Product: Defined as ePDU product with any product number sequence that does not equal a standard product as noted above. The Warranted item will be repaired at a Company site or such other location as determined by Company.

If the Warranted Item is to be replaced by Company, and the End-user supplies a credit card number or purchase order for the value of the replacement Product, Company will use commercially reasonable business efforts to ship (via standard ground shipment and at no cost to the End-user) the replacement Warranted Item to the End-user within one (1) business day after Company receives notice of the warranty claim. In such case, the End-user must return (at Company's expense) the defective Warranted Item to Company in the same packaging as the replacement Warranted Item received by the End-user or as otherwise instructed by Company. If Company does not receive the defective Warranted Item, Company will either charge the End-user's credit card, or send the End-user an invoice (which the End-user agrees to pay), for the value of the replacement Product.

If the Warranted Item is to be replaced by Company, but the End-user is unwilling or unable to supply a credit card number or purchase order for the value of the replacement Product, Company will use commercially reasonable business efforts to ship (via standard ground shipment and at no cost to the End-user) the replacement Warranted Item to the End-user within one (1) business day after Company receives the defective Product from the End-user.

In any case, Company will provide shipping instructions and will pay its designated carrier for all shipping charges for return of defective equipment and replacement of Warranted Items. Any returned Warranted Item or parts that are replaced may be new or reconditioned. All Warranted Items returned to Company and all parts replaced by Company shall become the property of Company.

WHAT THIS LIMITED WARRANTY DOES NOT COVER: This Warranty does not cover any defects or damages caused by: (a) failure to properly store the Product before installation; (b) shipping and delivery of the Product if shipping is FOB Factory; (c) neglect, accident, abuse, misuse, misapplication or incorrect installation; (d) repair or alteration not authorized in writing by Company personnel or performed by an authorized Company

Warranty

Customer Service Engineer or Agent; (e) improper testing, operation, maintenance, adjustment or modification of any kind not authorized in writing by Company personnel or performed by an authorized Company Customer Service Engineer or Agent; or (f) use of the Product under other than normal operating conditions or in a manner inconsistent with the Product's labels or instructions.

This Warranty is not valid if the Product's serial numbers have been removed or are illegible. Any Warranted Items repaired or replaced pursuant to this Warranty will be warranted for the remaining portion of the original Warranty subject to all the terms thereof.

Company shall not be responsible for any charges for testing, checking, removal or installation of Warranted Items.

COMPANY DOES NOT WARRANT EQUIPMENT NOT MANUFACTURED BY COMPANY. IF PERMITTED BY THE APPLICABLE MANUFACTURER, COMPANY SHALL PASS THROUGH SUCH MANUFACTURER'S WARRANTIES TO END-USER.

COMPANY DOES NOT WARRANT SOFTWARE (IF APPLICABLE TO THE PRODUCT), INCLUDING SOFTWARE EMBEDDED IN PRODUCTS, THAT IS NOT CREATED BY COMPANY. WITHOUT LIMITING THE FOREGOING, COMPANY SPECIFICALLY DOES NOT WARRANT SOFTWARE (SUCH AS LINUX) THAT WAS CREATED USING AN "OPEN SOURCE" MODEL OR IS DISTRIBUTED PURSUANT TO AN OPEN SOURCE LICENSE.

THIS WARRANTY IS THE SOLE AND EXCLUSIVE WARRANTY OFFERED BY COMPANY WITH RESPECT TO THE PRODUCTS AND SERVICES AND, EXCEPT FOR SUCH FOREGOING WARRANTY COMPANY DISCLAIMS ALL OTHER WARRANTIES INCLUDING BUT NOT LIMITED TO ANY IMPLIED WARRANTIES OF MERCHANTABILITY, TITLE, NON-INFRINGEMENT AND FITNESS FOR A PARTICULAR PURPOSE. CORRECTION OF NONCONFORMITIES IN THE MANNER AND FOR THE PERIOD OF TIME PROVIDED ABOVE SHALL CONSTITUTE COMPANY'S SOLE LIABILITY AND ENDUSER'S EXCLUSIVE REMEDY FOR FAILURE OF COMPANY TO MEET ITS WARRANTY OBLIGATIONS, WHETHER CLAIMS OF THE END-USER ARE BASED IN CONTRACT, IN TORT (INCLUDING NEGLIGENCE OR STRICT LIABILITY), OR OTHERWISE.

LIMITATION OF LIABILITY: The remedies of the End-user set forth herein are exclusive and are the sole remedies for any failure of Company to comply with its obligations hereunder. In no event shall Company be liable in contract, in tort (including negligence or strict liability) or otherwise for damage to property or equipment other than the Products, including loss of profits or revenue, loss of use of Products, loss of data, cost of capital, claims of customers of the End-user or any special, indirect, incidental or consequential damages whatsoever. The total cumulative liability of Company hereunder whether the claims are based in contract (including indemnity), in tort (including negligence or strict liability) or otherwise, shall not exceed the price of the Product on which such liability is based.

Company shall not be responsible for failure to provide service or parts due to causes beyond Company's reasonable control.

END-USER'S OBLIGATIONS: In order to receive the benefits of this Warranty, the End-user must use the Product in a normal way; follow the Product's user's guide; and protect against further damage to the Product if there is a covered defect.

OTHER LIMITATIONS: Company's obligations under this Warranty are expressly conditioned upon receipt by Company of all payments due to it (including interest charges, if any). During such time as Company has not received payment of any amount due to it for the Product, in accordance with the contract terms under which the Product is sold, Company shall have no obligation under this Warranty. Also during such time, the period of this Warranty shall continue to run and the expiration of this Warranty shall not be extended upon payment of any overdue or unpaid amounts.

COSTS NOT RELATED TO WARRANTY: The End-user shall be invoiced for, and shall pay for, all services not expressly provided for by the terms of this Warranty, including without limitation, site calls involving an inspection that determines no corrective maintenance is required. Any costs for replacement equipment, installation, materials, freight charges, travel expenses or labor of Company representatives outside the terms of this Warranty will be borne by the End-user.

OBTAINING WARRANTY SERVICE: In the USA, call the Customer Reliability Center 7x24 at 800.356.5737. Outside of the USA, contact your local Eaton product sales or service representative, or call the Customer Reliability Center in the USA at 919.870.3149. For comments or questions about this Warranty, write to the Customer Quality Representative, 3301 Spring Forest Road, Raleigh, North Carolina 27616 USA.

Warranty



P-16400014 1